

CLIMAVER[®]

Installation Guide





Table OF CONTENTS



P.5 CLIMAVER® SYSTEM

- **P.6** ISOVER's complete range of solutions for air-conditioning and ventilation ducts
- **P.7** CLIMAVER® - A comprehensive range to meet all your needs
- **P.9** CLIMAVER® range and local requirements
- **P.13** CLIMAVER® tools

P.19 THE STRAIGHT DUCT METHOD (SDM)

- **P.20** Producing ducts with the Straight Duct Method
- **P.21** Sealing of shapes
- **P.31** Production of shapes
- **P.42** Branches
- **P.51** Reductions

P.57 AUXILIARY OPERATIONS

- **P.58** Connection to a machine and other metal frames
- **P.61** Connection to a diffuser
- **P.63** Access hatches

P.69 SUPPORT AND REINFORCEMENTS

- **P.70** Reinforcements
- **P.73** Support

P.77 APPENDICES

- **P.78** CLIMAVER® METAL system
- **P.80** CLIMAVER® STAR assembly system
- **P.82** Pressure losses in CLIMAVER® ducts
- **P.89** Measurements in installations
- **P.91** Application restrictions
- **P.93** Waste management
- **P.94** Cleaning CLIMAVER® ducts
- **P.95** Panel development in straight sections table
- **P.97** CLIMAVER® technical data sheets

8 GOOD REASONS TO CHOOSE CLIMAVER®



Reduce your energy bill



Get greener



Engage for safe and healthy materials



Keep the noise down



Ensure fire safety



Ensure reliable, long-term performance



Minimise maintenance



Increase your site productivity

CLIMAVER[®] SYSTEM

- › ISOVER's complete range of solutions for air-conditioning and ventilation ducts
- › **CLIMAVER[®]** - A comprehensive range to meet all your needs
- › **CLIMAVER[®]** range and local requirements
- › **CLIMAVER[®]** tools

ISOVER's complete range of solutions FOR AIR-CONDITIONING AND VENTILATION DUCTS



1. SELF-SUPPORTING DUCTS CLIMAVER®



2. CHIMNEYS U PROTECT®



3. FIRE RATED DUCTS U PROTECT®



4. VENTILATION DUCTS CLIMCOVER



5. DUCT PENETRATIONS U PROTECT®



6. SEWAGE & RAIN WATER PIPES KAIVENIENCE



7. SMOKE EXTRACTION DUCTS U PROTECT®



8. BOILERS / TANKS CLIMCOVER



9. HOT WATER PIPES U PROTECT® PIPE SECTION ALU2



10. PIPE PENETRATIONS U PROTECT® PIPE SECTION ALU2 / KAIFLEX



11. COLD WATER PIPES KAIFLEX



12. FLEXIBLE DUCTS FLEXIVER



13. A/C DUCTS KAIFLEX



14. DUCTS OUTSIDE THE BUILDING CLIMAVER® STAR



15. AIR HANDLING UNIT KAISOUND

CLIMAVER® - A comprehensive range

A range of rigid, high-density glass wool panels made with thermosetting resins, giving it optimal properties to meet all the technical requirements necessary in air duct installations in terms of thermal, acoustic and fire considerations according to current regulations.

»» INNER FACING

The CLIMAVER® range has two types of inner facing: aluminium and net fabric, resistant to the highest demands for cleaning ducts using mechanical equipment, giving the net fabric better acoustic performance.

	Net fabric CLIMAVER® NETO CLIMAVER® A2 NETO CLIMAVER® DECO	Aluminium CLIMAVER® PLUS R CLIMAVER® A2 PLUS	
--	--	---	--

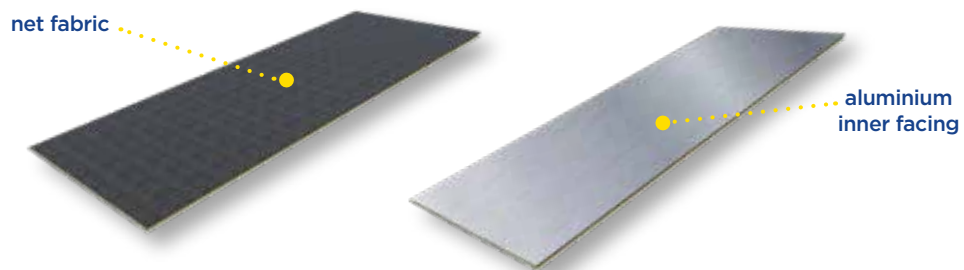





»» OUTER FACING

The entire CLIMAVER® range has outer facing that acts as a vapour barrier and creates airtightness for the duct. In CLIMAVER® STAR, the outer facing is made of embossed and plasticised aluminium with ultraviolet protection and moisture resistance, being the only self-supporting mineral wool panel suitable for direct use outdoors.

The facing of the other solutions in the CLIMAVER® range is made from aluminium, giving it the properties and requirements necessary for installation indoors. If it is installed on the building exterior, additional mechanical protection is required, for example by covering the duct with a metal sheet.

The CLIMAVER® DECO range has a special coating that gives it an aesthetic finish and is used mainly in exposed installations.

	Aluminum (SDM Marked)	CLIMAVER® NETO CLIMAVER® PLUS R CLIMAVER® A2 NETO CLIMAVER® A2 PLUS	CLIMAVER® APTA CLIMAVER® A1 APTA CLIMAVER® A2 APTA
	Embossed Aluminum (Ultraviolet Protection)	CLIMAVER® STAR	
	Deco fabric	CLIMAVER® A2 DECO 	

»» THICKNESS

The **CLIMAVER®** range is available in two thicknesses - 25 mm and 40 mm - to guarantee the requirements necessary indoors and outdoors, as well as to provide the highest thermal and acoustic efficiency in the installation.

	40 mm	CLIMAVER® APTA CLIMAVER® A1 APTA CLIMAVER® A2 APTA CLIMAVER® STAR	25 mm	CLIMAVER® NETO CLIMAVER® PLUS R CLIMAVER® A2 DECO CLIMAVER® A2 APTA CLIMAVER® A2 NETO	50 mm	CLIMAVER® APTA *On request
---	--------------	--	--------------	---	--------------	-------------------------------

»» REACTION TO FIRE

The **CLIMAVER®** range meets all fire requirements, providing a wide range of solutions ranging from Euroclass B-s1, d0 to A1, all of which are higher than the minimum required B-s3, d0 under most local laws.

	A1	CLIMAVER® A1 APTA	A2	CLIMAVER® A2 NETO CLIMAVER® A2 PLUS CLIMAVER® A2 APTA CLIMAVER® A2 DECO	B	CLIMAVER® APTA CLIMAVER® NETO CLIMAVER® PLUS R CLIMAVER® STAR
---	-----------	-------------------	-----------	--	----------	--

?

DID YOU KNOW?

One of the main characteristics of the **CLIMAVER®** exterior complex is its patented guide marking with lines at 22.5° (SDM marking), which makes it easier to cut the product. The **CLIMAVER®** outer facing also shows the airtightness line and the direction of the air circulation.

CLIMAVER® range AND LOCAL REQUIREMENTS

Applications

The CLIMAVER® range can be used to construct air distribution ducts in air conditioning and ventilation installations.

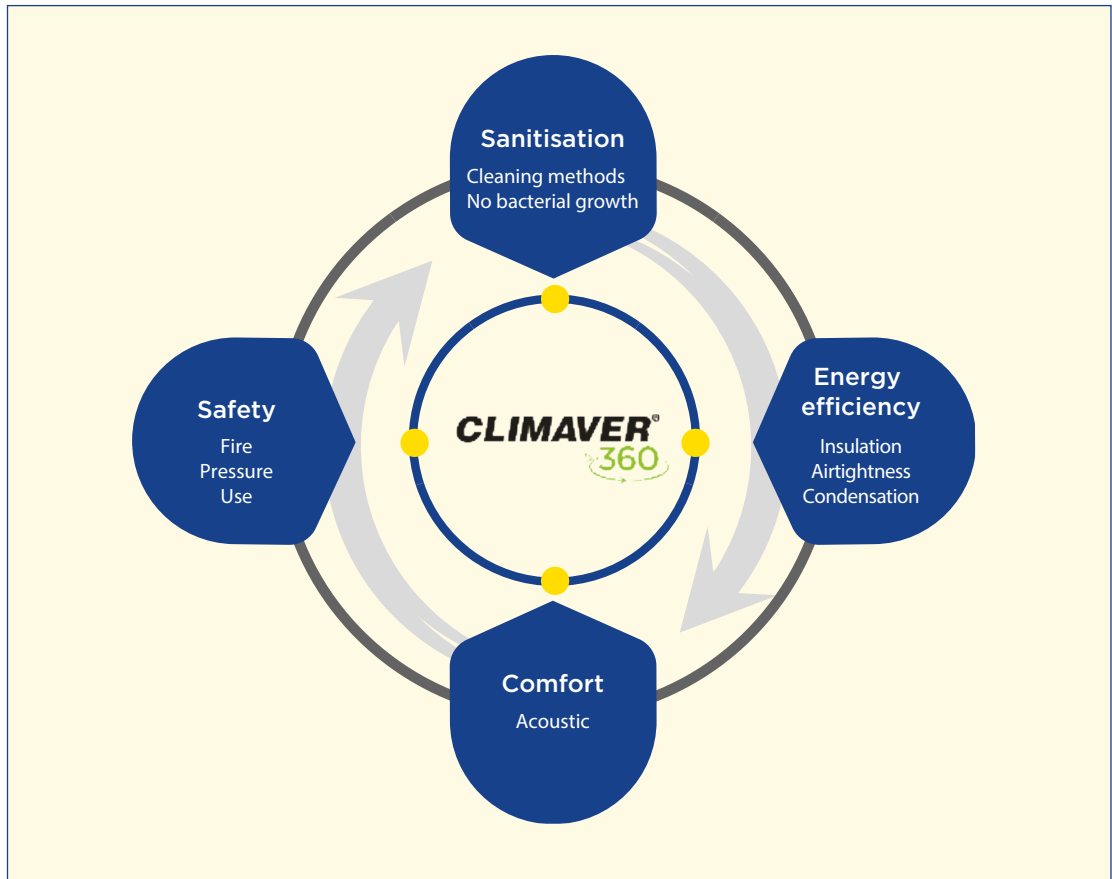

DID YOU KNOW? CLIMAVER® has over 50 years of history, and has evolved and continues to evolve.

- 1. CLIMAVER® SYSTEM
- 2. THE STRAIGHT DUCT METHOD (SDM)
- 3. AUXILIARY OPERATIONS
- 4. REINFORCEMENTS AND SUPPORT
- 5. APPENDICES



Energy efficiency

»» INSULATION

CLIMAVER® ducts meet and exceed the requirements for insulation in air ducts inside and outside buildings. CLIMAVER® Thermal Resistance 25 mm = 0.78 m² K/W vs. 0.75 m² K/W required inside buildings. CLIMAVER® Thermal Resistance 40 mm = 1.25 m² K/W equal to that required outside buildings in some countries

»» AIRTIGHTNESS

CLIMAVER® ducts feature maximum airtightness, which minimises air leaks, thereby optimising energy efficiency and the performance of the installation.

»» CONDENSATION

To avoid interstitial condensation, in addition to the thickness of the insulation, CLIMAVER® ducts have an outer facing of aluminium and kraft or aluminium only, with resistance to water diffusion greater than 50 Mpa.m².s/g acting as a vapour barrier.



CLIMAVER® range aluminium exterior facing with SDM guidelines

Acoustic comfort

»» ACOUSTIC

CLIMAVER® ducts help to improve an installation's acoustic comfort thanks to their high acoustic absorption coefficients. CLIMAVER® NETO, CLIMAVER® DECO, CLIMAVER® STAR and CLIMAVER® APTA are clear examples of sound absorbing solutions in the CLIMAVER® range.



Safety

»» FIRE

CLIMAVER® ducts comply with the fire safety requirement in facilities, exceeding the minimum requirement in most of the local legislations of reaction to fire B-s3, d0, in false ceilings and walls, and providing greater safety since all solutions in the **CLIMAVER®** range have a reaction to fire rating of at least B-s1, d0. Regarding most local fire laws, the **CLIMAVER®** range includes solutions with Euroclass A2-s1, d0 and A1, the latter being the best possible reaction to fire classification for an existing air conditioning and ventilation duct.



»» PRESSURE

CLIMAVER® ducts allow static pressures (positive and negative) of 800 Pa to be reached. The pressure tests carried out on **CLIMAVER®** ducts under the European Standard EN 13403 have been tested at 2.5 times the declared maximum working pressure (2,000 Pa).

»» USE/DURABILITY

CLIMAVER® ducts have successfully passed accelerated ageing tests based on multiple cycles of variation in temperature and humidity.

Sanitisation

»» CLEANING METHODS

CLIMAVER® ducts can be inspected and cleaned with the most commonly used mechanical cleaning methods (brushing, pressurised air, suction, etc.), having been tested and certified.

»» NO BACTERIAL GROWTH

According to an independent laboratory test, **CLIMAVER®** ducts do not promote the development of microorganisms or moulds.



Self-supporting ducts were invented in the USA more than 50 years ago.

DID YOU KNOW?

Sustainability

Comparing a **CLIMAVER®** duct with a conventional metal duct insulated on the outside with mineral wool, we can see that not only the installation time and costs are higher with a metal duct, but also the environmental impact it causes versus a **CLIMAVER®** duct is higher (approximately 20%).

Life Cycle Analysis (LCA) and Environmental Product Declarations (EPDs) are the best scientifically-based tools to assess the environmental impact of products throughout their useful life of all solutions in the **CLIMAVER®** range. They have a Type III EPD, meaning they are verified by a third party.

The LCA rigorously calculates the use of energy, water and natural resources, the emissions released into the air, land and water, and the generation of waste. This data is calculated for each stage of the building's Life Cycle; from the extraction of raw materials in the materials that make up the building, to the transport of these raw materials, the environmental aspects associated with the materials production process, the transport of these materials to the site, the use and maintenance of the building constructed and, lastly, its demolition and the management of the waste produced: «from cradle to grave».

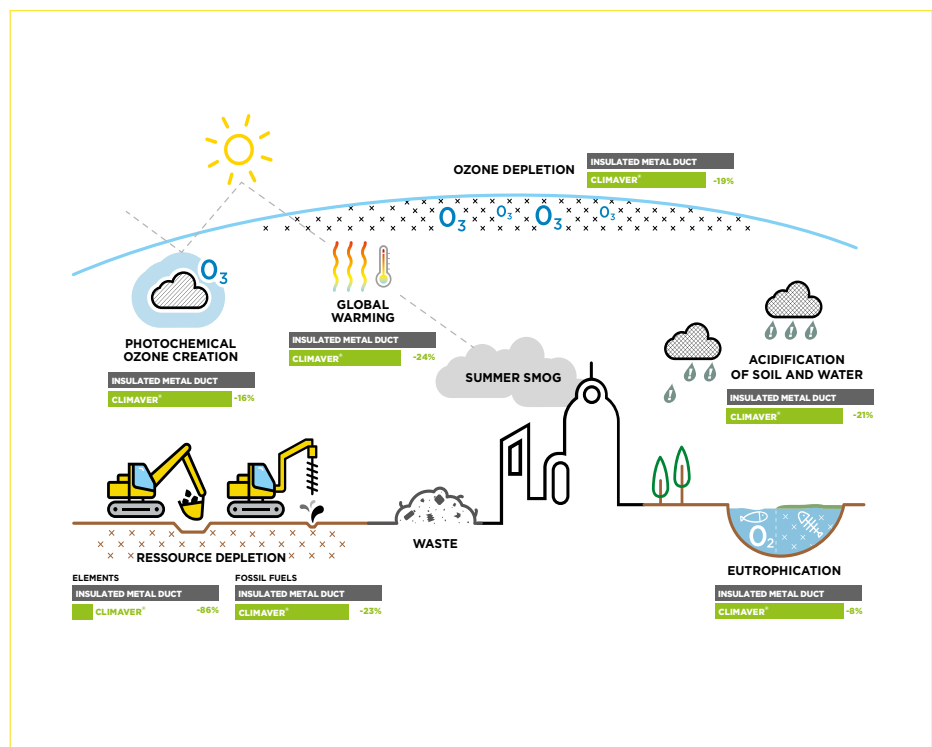

CLIMAVER® TOOLS

CLIMAVER® Tool Kit

Tool kit for CLIMAVER® 25 mm panels, used for cutting and forming shapes using the SDM. (Straight Duct Method).



The image shows an open black tool kit with a pink interior. Various tools are arranged in their compartments. Dotted lines connect callout boxes to specific tools. The callouts include:

- CALIBRATOR PLUG**: 25 MM BLADE HEIGHT. (Callout points to a white plug in the top left compartment).
- RED TOOL**: HALF-LAP JOINT LONGITUDINAL CUT. (Callout points to a red tool in the top right compartment).
- SHIPLAP TOOL**: MECHANISES MALE AND FEMALE ELEMENTS. (Callout points to a black shiplap tool in the middle right compartment).
- BLUE TOOL**: HALF-LAP JOINT AND OVERLAP LONGITUDINAL CUT. (Callout points to a blue tool in the bottom left compartment).
- STRAIGHT SDM TOOL**: STRAIGHT CUT FOR FORMING SHAPES. (Callout points to a green tool in the bottom middle compartment).
- INCLINED SDM TOOL**: CUTS AT 22.5° FOR FORMING SHAPES. (Callout points to a green tool in the bottom right compartment).

CLIMAVER® Universal Tool Kit

Tool Kit for CLIMAVER® 25 mm and 40 mm panels to cut and form shapes using the SDM. (Straight Duct Method).



CLIMAVER® Universal Angle Guide



» CLIMAVER® Universal Angle Guide: Aluminium angle guide with the most common predefined angles (90°, 45° and 22,5°) for use with CLIMAVER® Universal Tools. Simplifies the measurement and duct cutting operations.

CLIMAVER® MM Angle Guide

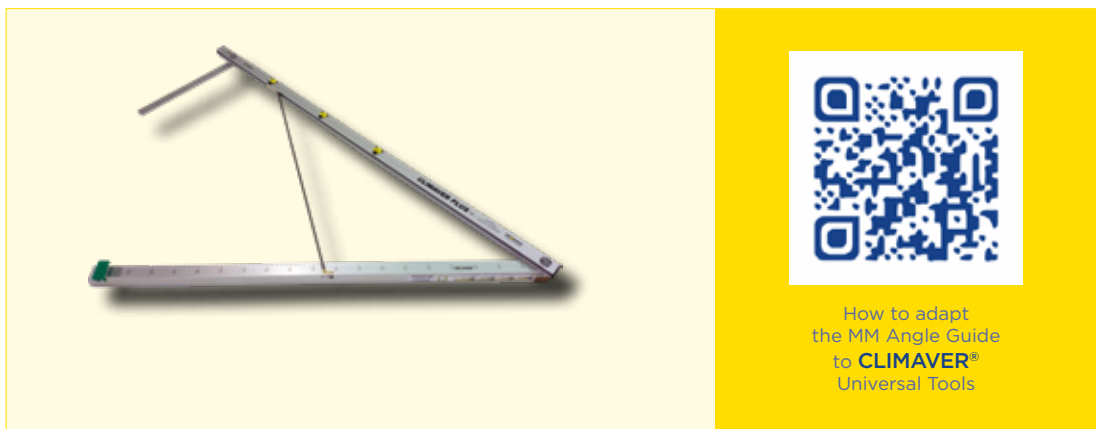

» CLIMAVER® MM Angle Guide: Aluminium angle guide with the most common predefined angles (90°, 45° and 22.5°) for use with CLIMAVER® MM Tools. Simplifies the measurement and duct cutting operations.

?

DID YOU KNOW?

An adapter sticker is available so that the CLIMAVER® MM Angle Guide can be used with the CLIMAVER® Universal tool case, as well as for using the CLIMAVER® Universal Angle Guide with the CLIMAVER® Tool kit.

Other tools



»» CLIMAVER® Stapler provides gentle handling for stapling flaps and joints.



»» CLIMAVER® Knife suitable for auxiliary cuts, featuring two edges, one sharp and the other blunt. Support accessory during duct assembly.

CLIMAVER® Metal system profile accessories

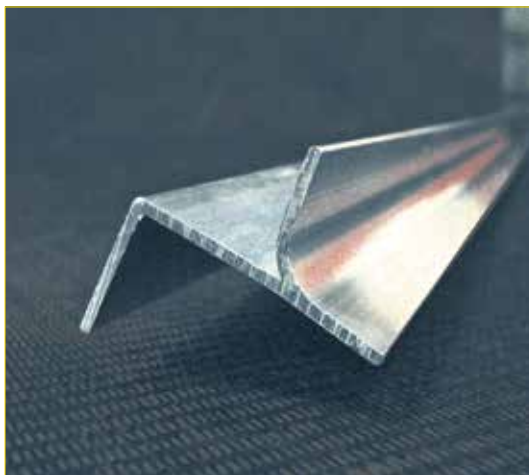

»» **Perfiver L:**
Aluminium profile designed for shaping ducts using the CLIMAVER® METAL system method.



»» **Perfiver H:**
Aluminium profile especially designed for making inspection hatches or panels, connections to a machine and/or grilles or diffusers, as well as the reinforcement joints between pieces made using the SDM.

Available for 25 mm and 40 mm thick panels.

CLIMAVER® tapes and Glues



»» CLIMAVER® Aluminium Tape:
Aluminium Tape 50 microns thick and 63 mm wide, for the external sealing of CLIMAVER® ducts.



»» CLIMAVER® Glue:
Vinyl Glue in aqueous dispersion designed for joints between mineral wool and sealing when making SDM. shapes.



»» CLIMAVER® STAR Tape:
Acrylic-based embossed Aluminium Tape 75 mm thick and 190 microns thick, for the external sealing of CLIMAVER® STAR self-supporting ducts in installations on building exteriors.



»» CLIMAVER® STAR Glue:
Mounting Glue designed for sealing in the realization of CLIMAVER® STAR SDM forms in building exteriors.

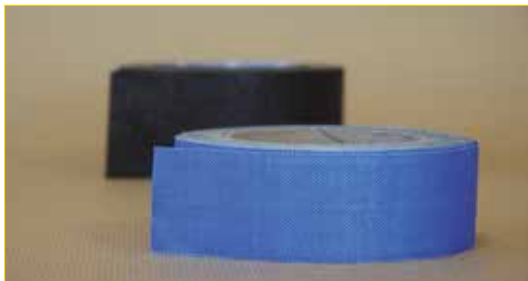

»» CLIMAVER® A2 DECO Tape:
Coloured glass fabric tape for exterior sealing of CLIMAVER® DECO ducts.

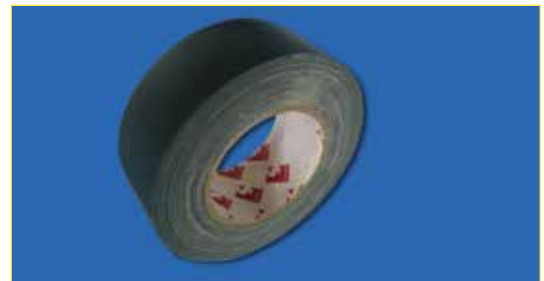

»» CLIMAVER® NETO Tape:
Tape for sealing inside the duct with net fabric tape.

Other accessories



» CLIMAVER® Staples:
58/14 mm staples for use with the CLIMAVER® Stapler.

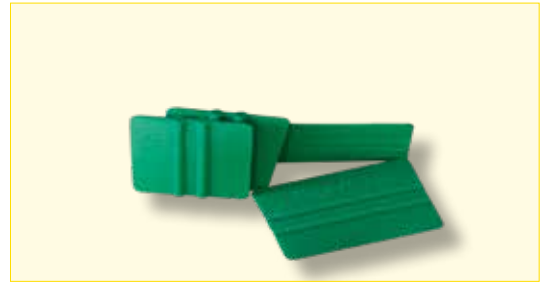

» CLIMAVER® Spatulas:
Semi-flexible plastic spatulas for the external sealing of ducts with CLIMAVER® Tape.



THE STRAIGHT DUCT METHOD (SDM)

- › Producing ducts with the Straight Duct Method
- › Sealing of shapes
- › Production of shapes
- › Branches
- › Reductions

Producing ducts with the STRAIGHT DUCT METHOD

ISOVER developed and patented the straight duct method, which involves producing the different successive shapes in a CLIMAVER® duct network from a straight duct. By following the marking of the 22.5° guide lines and cutting directly using the SDM blades, it is possible to make up the different 45° angle pieces that make up the final shape.



SDM ADVANTAGES OVER THE TRADITIONAL DUCT SYSTEM

- › **Easy and simple** to assemble
- › **Quick and time-saving** execution
- › **Optimal interior finish** of the duct
- › **Reduces** the generation of **waste** on site
- › **Minimises** the machining of male and female elements at duct joints

?

**DID YOU
KNOW?**

Traditionally, the shapes for an air-conditioning-ventilation installation were entirely made with the layout on the panel of each of the different pieces that make up the shape, subsequently cutting and assembling them to achieve the intended shape. This is known as the traditional covers, parts or risers method.



The straight duct is the starting point in any installation for forming the different shapes planned throughout the installation.

The most common way of working is to make a duct from a single piece, making three half-lap joint cuts with the red tool and a closing overlap with the blue tool. Sometimes, due to the sections of the ducts, it is not possible to make a duct from a single panel, and combinations are required that will use two L-shaped pieces, a U-shaped piece and Cover, or four pieces, as detailed in this manual.

This way of working also applies to making smaller section ducts, using leftovers from previously used panels, to make the most of the entire CLIMAVER® panel, thereby obtaining maximum output from the CLIMAVER® panel.



**DID YOU
KNOW?**

CLIMAVER® Tools and the CLIMAVER® Angle Guide make it possible to produce straight ducts directly with the interior measurements of the sections to be made, making the production of self-supporting ducts fast and easy.

Production of a one-piece straight duct

For making a straight duct with the internal measurement (a x b) use the red and blue tools, and the **CLIMAVER® Angle Guide** for transferring the measurements. As a general rule, all of the cuts described are made starting from the male edge of the panel and moving towards the female edge.

THE ANGLE GUIDE DIRECTLY TRANSLATES THE INTERNAL MEASUREMENTS OF THE DUCT SO THAT IT CAN BE CUT AND FORMED WITHOUT THE NEED FOR ANY ADDITIONAL CALCULATION, AS IT HAS INTEGRATED THE MEASUREMENTS CORRESPONDING TO THE FOLDING OF THE DUCT SIDES AT 90°.



Video of straight duct production

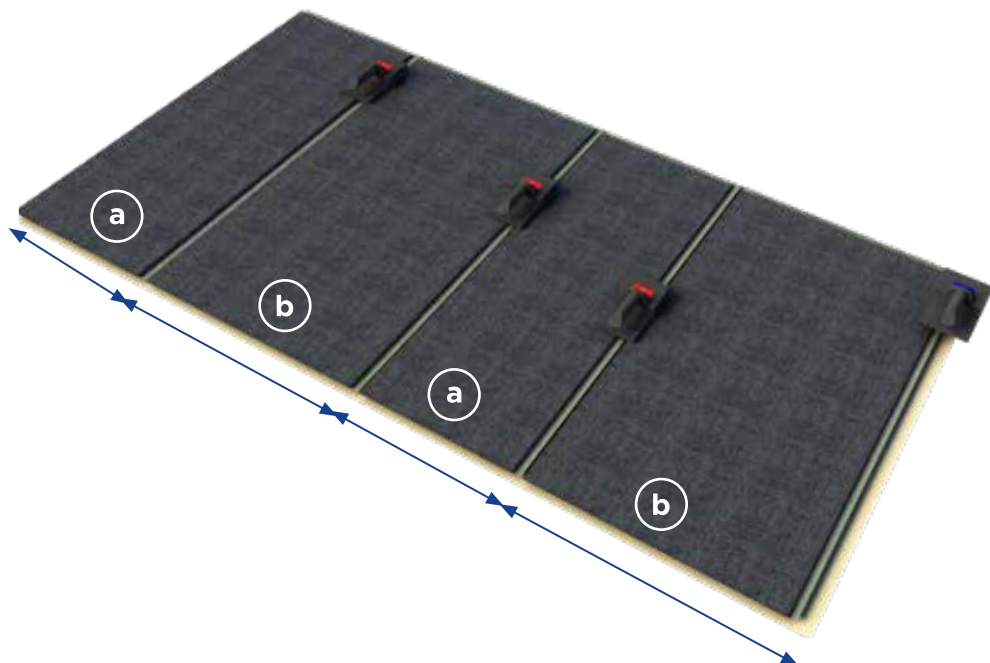

Half-lap joint cuts for forming a CLIMAVER® straight duct with the dimensions (a x b)

A duct with the internal dimensions (a x b) of a straight section of a piece is made as follows:

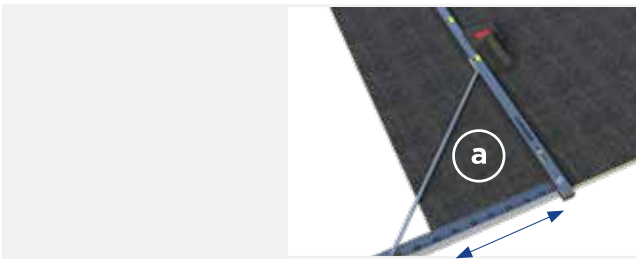

› STEP 1

The **CLIMAVER® Angle Guide** is placed, with the internal measurement of the duct being made, on the left edge of the panel, aligning side (a) on the lower part of the **CLIMAVER®** guide and with the upper guide.

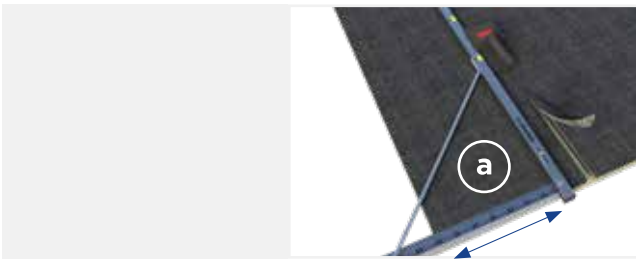

› STEP 2

The **CLIMAVER® Angle Guide** is pressed with one hand to prevent it from moving during the longitudinal cut, and with the other hand the red tool is passed along the side of the guide, closely following the tool and continuing the cut to the end of the panel.

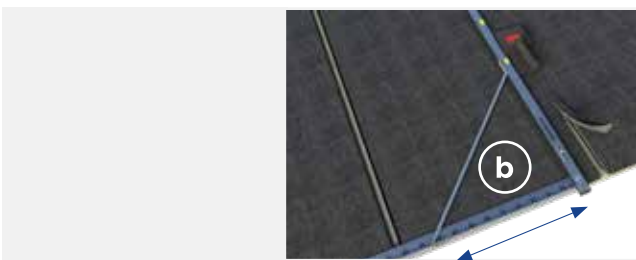

› STEP 3

Step (2) is repeated with the inner section of side (b), placing the measurement of the guide in the cut the furthest to the right and passing the blue tool over it.

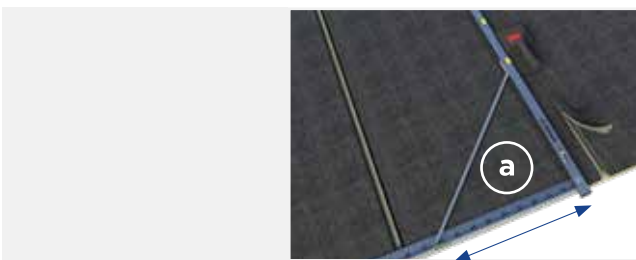

› STEP 4

Step (2) is repeated with the inner section of side (a), placing the measurement of the guide in the cut of the previous measurement the furthest to the right and passing the red tool.

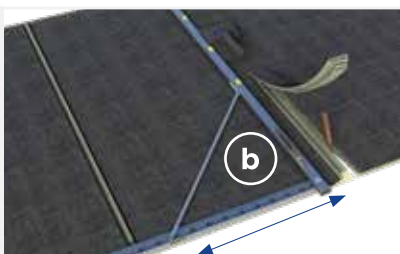

› STEP 5

Repeat step (2) with the inner section of side (b) using the blue tool to obtain the closing overlap of the duct, placing the measurement of the guide in the cut of the previous measurement the furthest to the right.



› STEP 6

Once the four cuts have been made using the **CLIMAVER® Tools**, the panel is cut using the **CLIMAVER® Knife** at the end of the slit marked by the blue tool to separate the duct from the rest of the panel.

To remove the longitudinal strips of mineral wool made in half-lap joints, slightly fold the panel in each of the cuts, opening it in a «V» to completely remove the cuts.



› STEP 7

In order to be able to close the duct, the overlap left by the blue tool is cleaned using the blunt side of the **CLIMAVER® Knife**.



› STEP 8

To form the duct, fold the sides at 90°; the perpendicular guide lines marked on the outer complex make it easier to square when making the duct.



› STEP 9

Next, position the overlap firmly to perform the longitudinal stapling, with 3 cm - 5 cm between staples.

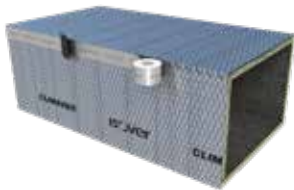

› STEP 10

The duct is sealed longitudinally using **CLIMAVER® Aluminium Tape**, adhering half on the overlap and the other half on the duct, pressing with the spatula and rubbing in the same direction up and down several times to ensure adhesion.

FORM OBTAINED: STRAIGHT SECTION OF THE **CLIMAVER®** DUCT



CLIMAVER® straight duct

Production of an (L + L) duct

To produce a duct with the internal dimensions (a x b) by joining two L-shaped pieces, the following steps must be carried out:

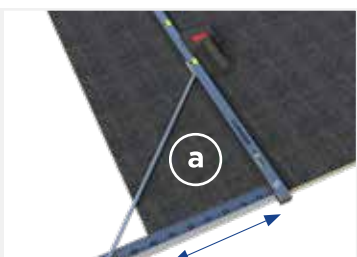

› STEP 1

The **CLIMAVER® Angle Guide** is placed with the inside measurement of the duct to be made, from the left edge of the panel, aligning side (a) with the lower part of the **CLIMAVER® Angle Guide** and with the upper guide.

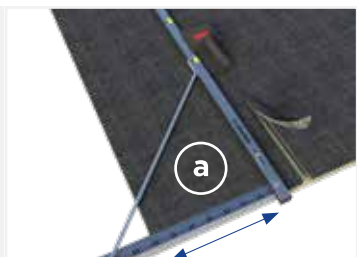

› STEP 2

The **CLIMAVER® Angle Guide** is pressed with one hand to prevent it from moving during the longitudinal cut, and with the other hand the red tool is passed on the side, closely following the tool and continuing the cut to the end of the panel.

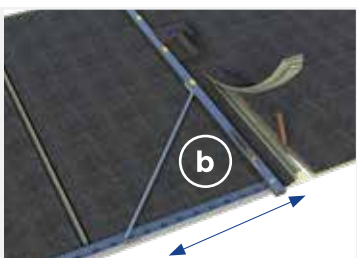

› STEP 3

Step (2) is repeated with the inner section of side (b), placing the measurement of the guide in the cut the furthest to the right and passing the blue tool over it. In this way, an (L) shaped panel is obtained, with one of its sides straight and the other ending in an overlap.

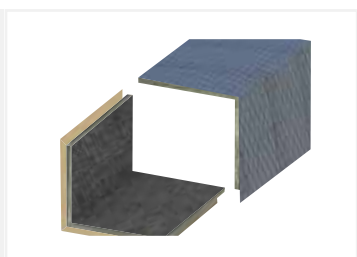

› STEP 4

By repeating this operation, a second (L) shaped piece is obtained, with which the straight duct is formed. To seal the duct, staple and tape both overlaps with **CLIMAVER® Aluminium Tape** on their respective sides.

Production of a duct (U + COVER)

A duct (a x b) joining two U-shaped pieces and a Cover is made as follows:



› STEP 1

The **CLIMAVER® Angle Guide** is placed with the inside measurement of the duct to be made, from the left edge of the panel, aligning side (a) with the lower part of the **CLIMAVER® Angle Guide** and with the upper guide.

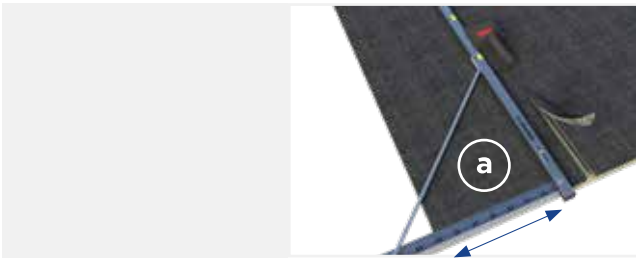

› STEP 2

The **CLIMAVER® Angle Guide** is pressed down with one hand to prevent it from moving during the longitudinal cut, and with the other hand the red tool is passed on the side, closely following the tool and continuing the cut to the end of the panel.

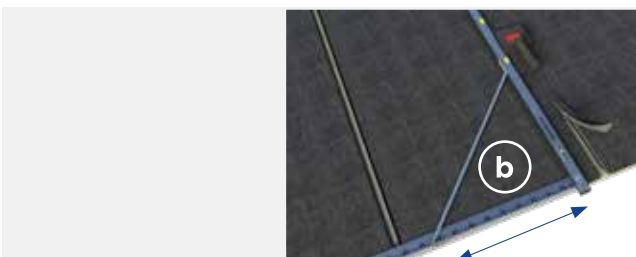

› STEP 3

Repeat step (2) with the inner section of the other side (b), placing the measurement of the guide in the cut the furthest to the right and passing the red tool over it.

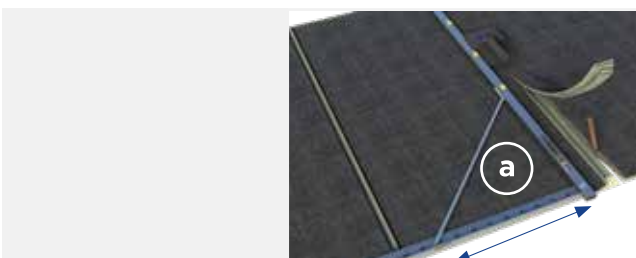

› STEP 4

Step (2) is repeated again with the inner section of side (a), placing the measurement of the guide in the cut of the previous measurement the furthest to the right and passing the blue tool over it.

In this way, a (u) shaped panel is obtained, with one of its sides straight and the other ending in an overlap.

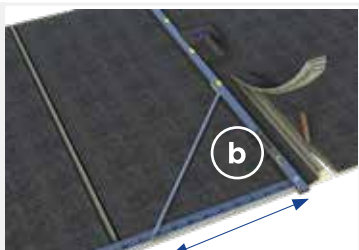

› STEP 5

Lastly, to make the closing cover of the duct, transfer the internal measurement of the duct (b) using the **CLIMAVER® Angle Guide** and make a cut passing the blue tool over it.



› STEP 6

With the pieces obtained (U + Cover), seal the duct by stapling and taping with **CLIMAVER® Aluminium Tape** on both overlaps on their respective sides.



Production of a four-piece duct

This working method is fundamental for all of the shapes made using the traditional Covers, Pieces or Risers method.

Although it is not common to use this working method when making straight ducts, it is used for making large sections of ducts and to make the most of the remnants of the **CLIMAVER®** panel. There are essentially two ways to make the shape:

A



Produce four pieces with an overlap and a straight side.

Transfer the internal measurement of the duct (a x b) of each of the pieces that will form part of the duct and pass the blue blade so that four pieces are obtained, with one of their sides straight and a closing overlap on the other. With the four pieces obtained, seal the duct by stapling and taping with **CLIMAVER® Aluminium Tape** on both overlaps on their respective sides.

B



Produce four pieces, two with a double overlap and two straight.

Cut the straight pieces with a blade, adding 2 cm more to the interior measurement of the duct, since later on when the four pieces are assembled the surrounds of the overlaps remain 1 cm on each side.

The pieces with a double overlap are cut to the interior measurement of the duct, the blue tool is passed in two directions, from the male to the female on one side and from the female to the male on the other side so that the step mounts of the straight covers match the interior measurement of the duct and the overlap on the outside to enable the four pieces to be formed.

To make a 4-piece duct it is necessary to increase by 2 cm the straight 25 mm **CLIMAVER®** pieces and by 4 cm the 40 mm **CLIMAVER®** straight pieces.

DID YOU KNOW?

Sealing OF SHAPES

Exterior sealing

CLIMAVER® ducts are sealed externally using **CLIMAVER® Aluminium Tape**, to guarantee the airtightness specified in the product technical sheets.

Both in the longitudinal joints of panels to obtain straight ducts and in the transverse joints between ducts, the sealing is performed after stapling the exterior facing, by means of taping, using **CLIMAVER® Aluminium Tape**. Half the width of the tape is adhered to the overlap already stapled and the other half to the surface of the duct.



Video of sealed joints
in straight ducts



CLIMAVER® Exterior longitudinal sealing of
a CLIMAVER® duct with CLIMAVER® Aluminium Tape



Transverse joints between ducts

Inner sealing

This operation is used to join pieces to obtain shapes using the Straight Duct Method (elbows, branches, bifurcations, etc.).

Seal by applying a bead of **CLIMAVER® Glue** on the glass wool surface of one of the pieces to be joined, next to the edge of the interior facing and completing the interior perimeter of the section. The shapes are then sealed on the outside using **CLIMAVER® Aluminium Tape**.

Once taped with **CLIMAVER® Aluminium Tape** externally, the figures can be installed immediately in the ductwork. A 24-hour drying time is recommended before starting up the installation.



Interior sealing of SDM shapes using CLIMAVER® Glue

**DID YOU
KNOW?**

An interior seal must be made using **CLIMAVER® Glue**. Subsequently the exterior of the shape is then sealed using **CLIMAVER® Aluminium Tape**.

Production OF SHAPES

This manual details the production of shapes in an installation using the Straight Duct Method (SDM) starting from the production of a straight duct and using the guide lines (22.5°) marked on the exterior complex that allows shapes to be cut and formed.



Shapes are the parts of the installation in which there is a change of direction in the air circulation.

In addition to the Straight Duct Method (SDM), shapes can be made using the layout on the panel of each of the different pieces that make up the shape, subsequently cutting and assembling them to obtain the planned shape, then sealing the different parts using CLIMAVER® Tape and Staples.

Elbows and deviations or angle elbows

The basis of the Straight Duct Method (SDM) involves making shapes from the production of a straight section. The basic shapes of this method, such as the elbow and the deviation, are used to subsequently be able to execute any branch.



Video of elbow production



Video of offset production

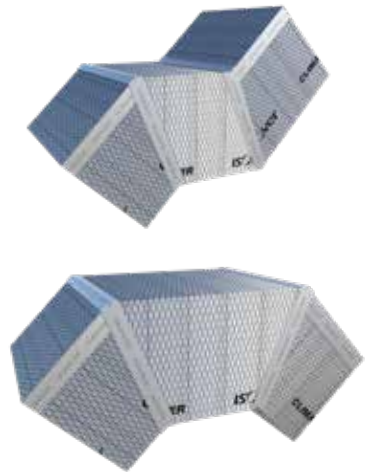

By making cuts at 22.5° following the guide lines of the exterior complex of the CLIMAVER® panel, 45° angles can be obtained with changes of direction with minimal load losses.

**DID YOU
KNOW?**

90° elbow fabrication

Steps to take starting with a straight section duct (a x b):



› STEP 1

Make a first cut on the horizontal face of the duct with the blade straight following a guide line at 22.5° marked on the **CLIMAVER®** exterior complex.

Then transfer the radius distance and make a second non-parallel cut with the blade straight following the 22.5° guideline.



› STEP 2

On a straight side, make a cut with the blade inclined at 22.5°, orienting the blades in the direction of the angle obtained with the cuts of the straight blade.

Repeat the straight cuts on the opposite side with the blade inclined at 22.5°.



› STEP 3

Lastly, with the blade straight, cut the lines at 22.5° to join the previously cut lateral straight lines.



› STEP 4

Seal by applying a bead of **CLIMAVER® Glue** on the glass wool surface of one of the pieces to be joined, next to the edge of the interior facing and completing the interior perimeter of the section.



› STEP 5

It is sealed on the outside with **CLIMAVER® Aluminum Tape**, wrapping the entire figure around the perimeter.

Diagram and table of the distances of the lead radius of an elbow



SEPARATION A (CM)	15	20	25	30	35	40	45	50	55	60
DISTANCE D (CM) FLOOR	10.6	14.1	17.7	21.2	24.7	28.3	31.8	35.4	38.9	42.4



CLIMAVER® duct installation SDM elbow

Schematic production of an elbow

ELBOW 90°

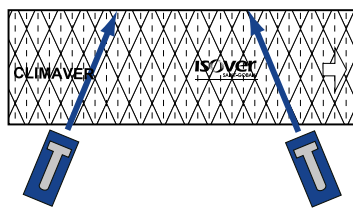

TURN 180°

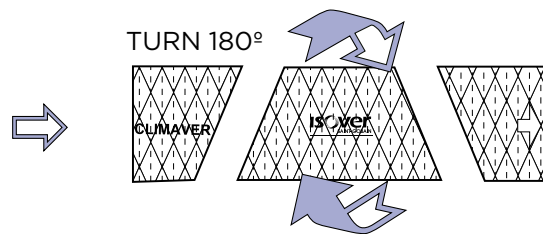

SEAL WITH CLIMAVER®
GLUE AND TAPE

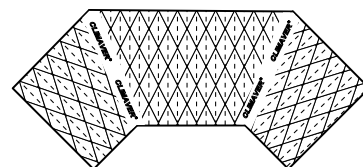
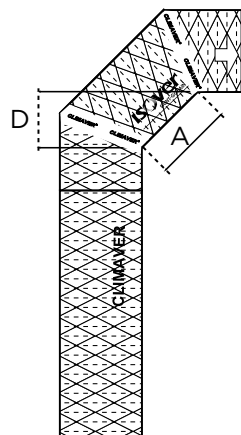

OFFSET MANUFACTURING

Steps to take starting with a straight section duct (a x b).

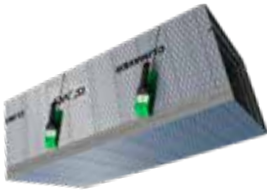

› STEP 1

Make a first cut with the blade straight following a guide line at 22.5° marked on the **CLIMAVER®** exterior complex. Then transfer the deviation distance and make a second cut parallel to the straight blade following the 22.5° guideline.



› STEP 2

Cut both sides with the blade inclined at 22.5°, orienting the blades in the direction of the angle obtained with the cuts of the straight blade.

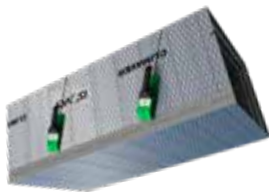

› STEP 3

Lastly, with the blade straight, cut the lines at 22.5° to join the previously cut lateral straight lines.



› STEP 4

Rotate the central element obtained 180°; the distance of the turning radius determines the advance of the shape and the pressure losses.



› STEP 5

Seal by applying a bead of **CLIMAVER® Glue** on the glass wool surface of one of the pieces to be joined, next to the edge of the interior facing and completing the interior perimeter of the section.



› STEP 6

It is sealed on the outside with **CLIMAVER® Aluminium Tape**, taping around the entire perimeter of the shape.



Diagram and table of installation distances

Below is a table showing the advances of the shape as a function of the turning radius.



SEPARATION A (CM)	20	25	30	35	40	45	50	55	60	65	70	75	80
DISTANCE D (CM) FLOOR	14.1	17.7	21.2	24.7	28.3	31.8	35.4	38.9	42.4	46	49.5	53	56.6



Schematic production of an Offset

Offset

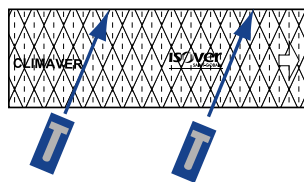

Turn 180°

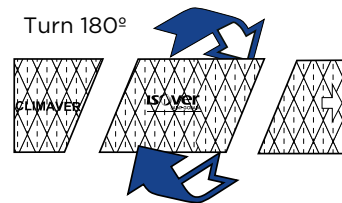

Seal with CLIMAVER®
GLUE and TAPE

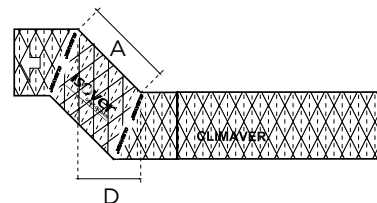
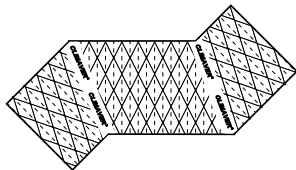

45° deviation

Steps to take Starting with a straight section duct (a x b).



› STEP 1

Make a first cut with the blade straight following a guide line at 22.5° marked on the **CLIMAVER®** exterior complex.



› STEP 2

Cut both sides with the blade inclined at 22.5°, orienting the blades in the direction of the angle obtained with the cuts of the straight blade.

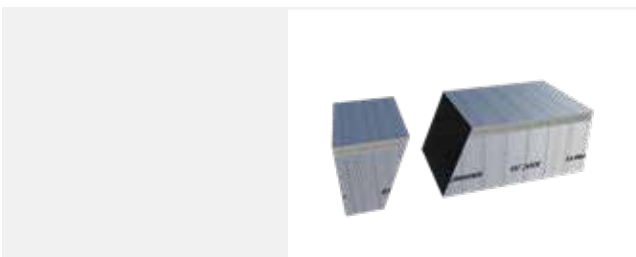

› STEP 3

Lastly, with the blade straight, cut the lines at 22.5° to join the lateral straight lines.



› STEP 4

Seal by applying a bead of **CLIMAVER® Glue** on the glass wool surface of one of the pieces to be joined, next to the edge of the interior facing and completing the interior perimeter of the section.

It is sealed on the outside with **CLIMAVER® Aluminium Tape**, taping around the entire perimeter of the shape.

Beampass

Steps to take starting with a straight section duct (a x b):



› STEP 1

On the side of the duct, plot the rise-and-fall double angle elbow separated by the distance of the beam to cross (a), with the lines parallel at 22.5°.

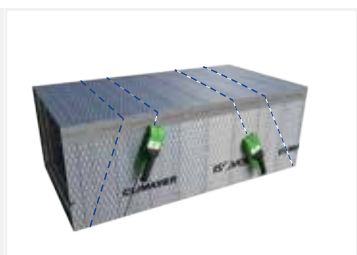

› STEP 2

The cuts are made on the vertical side of the duct with the straight blade following the 22.5° guide lines marked on the **CLIMAVER®** exterior facing.



› STEP 3

Cut the adjoining sides marked with straight lines with the blade inclined at 22.5°, first orienting the blades in the direction of the angle previously obtained from the cuts of the straight blade.



› STEP 4

Lastly, with the blade straight, cut the lines at 22.5° to join the straight lines of the upper and lower face.



› **STEP 5**

Seal by applying a bead of **CLIMAVER® Glue** on the glass wool surface of one of the pieces to be joined, next to the edge of the interior facing and completing the interior perimeter of the section.



› **STEP 6**

It is sealed on the outside with **CLIMAVER® Aluminium Tape**, taping around the entire perimeter of the shape.



CLIMAVER® duct installation SDM Beampass

BRANCHES

Simple dynamic branch

This is a shape that, starting with a main branch, produces a branch or change of direction of the air laterally, reducing or enlarging the main section that continues straight.

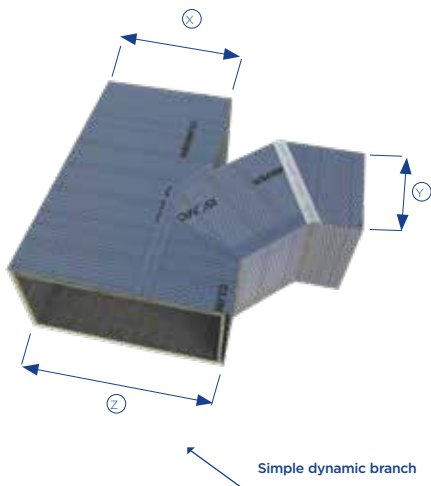

Video of branch production

TO MAKE A SIMPLE DYNAMIC BRANCH, START WITH A STRAIGHT MAIN DUCT (EXTERNAL MEASUREMENT Z), TO CONTINUE WITH ANOTHER STRAIGHT DUCT OF A SMALLER SECTION (EXTERNAL MEASUREMENT X) AND BIFURCATE ON THE SIDE WITH AN OUTLET AT 45° (EXTERNAL MEASUREMENT Y).

To join the lateral sections of exterior sections (X) and (Y), take into account the exterior section of the main duct, (Z), to achieve a geometric distribution of the difference in sections of the two ducts, (X + Y) with respect to (Z).

This means that, for example, if the outer outlet sections of the two lateral ducts are (X and Y = 30 cm) and the main section is Z = 50 cm, the measurement to be distributed is first calculated by adding the measurements of the outlet ducts, (X = 30 cm + Y = 30 cm) and subtracting the measurement of the main duct (Z = 50 cm). The resulting measurement (10 cm) in this example is 50% distributed between the two outlet ducts, 5 cm to each duct.

To ensure the correct connection of the ducts, the secondary ducts must be connected from the female side to the male side of the main duct.

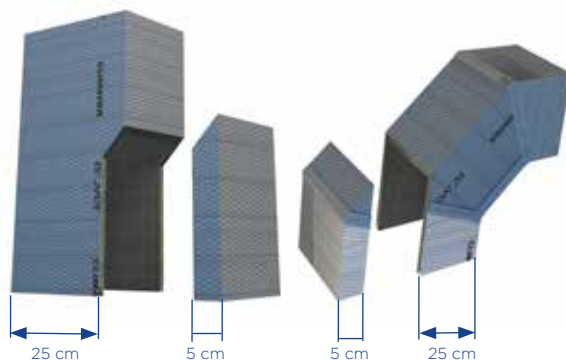

ALL LONGITUDINAL CUTS ARE CUT STRAIGHT AND LATERAL CUTS ARE MADE AT 45° TO FACILITATE THE ASSEMBLY AND GIVE GREATER CONSISTENCY TO THE JOINTS; IT IS RECOMMENDED TO MAKE OVERLAPS IN ONE OF THE SHAPES, IN ADDITION TO SEALING THE JOINTS USING CLIMAVER® GLUE.

A simple dynamic branch is made as follows:



› STEP 1

Once the ducts of the branch and straight section that continues have been made, make the geometric division with respect to the main duct and cut with the blade straight.

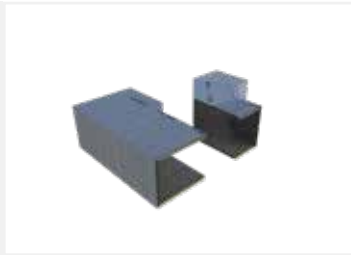

› STEP 2

After making the branch cut (outlet at 45°), project the measurement to the straight section to determine the point of intersection between both ducts, and on this draw a 45° angle towards the outside so that both ducts can be connected, since the branch is introduced into the straight section acting as a deflector to divert the air inside the duct.



› STEP 3

Seal by applying a bead of **CLIMAVER® Glue** on the glass wool surface of one of the pieces to be joined, next to the edge of the interior facing and completing the interior perimeter of the section.



› STEP 4

It is sealed on the outside with **CLIMAVER® Aluminium Tape**, taping around the entire perimeter of the shape.

Double dynamic branch «trousers»

This is a shape that, starting from a main branch, produces at the same point a double lateral branch towards two of its sides.

A double dynamic branch is made starting from the outer measurement of a straight section (Z), in which we know the flow and speed, and from that point we move laterally at 45° with an outer section (X) and we move laterally towards the other side at 45° with a duct with the external measurement (Y).

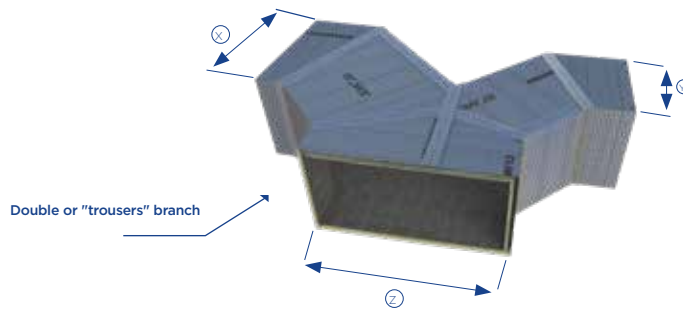

Video of double dynamic branch production

This means that, for example, if the outer outlet sections of the two lateral ducts are 30 cm and the main section is 50 cm, the measurement to be distributed is first calculated by adding the measurements of the outlet ducts ($X = 30 \text{ cm} + Y = 30 \text{ cm}$) and subtracting the measurement of the main duct ($Z = 50 \text{ cm}$). The resulting measurement (10 cm) in this example is 50% distributed between the two outlet ducts, 5 cm to each duct.

To ensure the correct connection of the ducts, the secondary ducts must be connected from the female side to the male side of the main duct.

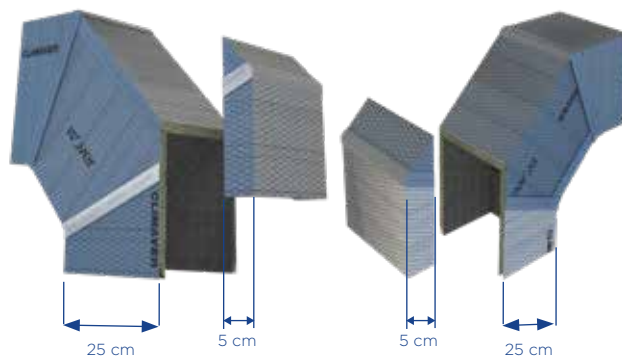

Double or "trousers" branch production

ALL LONGITUDINAL CUTS ARE MADE STRAIGHT AND SIDE CUTS ARE MADE AT 45°. TO FACILITATE ASSEMBLY AND GIVE MORE CONSISTENCY TO THE JOINTS, IT IS RECOMMENDED TO MAKE OVERLAPS IN SOME OF THE SHAPES, IN ADDITION TO SEALING THE JOINTS USING CLIMAVER® GLUE.

A double or “trousers” bifurcation is made as follows:



› STEP 1

Make the lateral branches starting from the female side, at 45°/90°.

Bear in mind that when constructing a trousers shape, the height of the branches must meet at their first vertex from the female. If they do not meet, the two branches are joined using the single branch methodology, in which one branch is inserted into the other.



› STEP 2

Once the distribution is obtained, transfer the measurements to the branches until the 45° outlet. Make all longitudinal cuts straight and side cuts with a blade at 45°.

To facilitate the assembly and give greater consistency to the joints, it is recommended to make overlaps in one of the shapes, in addition to sealing the joints using **CLIMAVER® Glue**.



› STEP 3

Seal by applying a bead of **CLIMAVER® Glue** on the mineral wool surface of one of the pieces to be joined, next to the edge of the interior facing and completing the interior perimeter of the section.

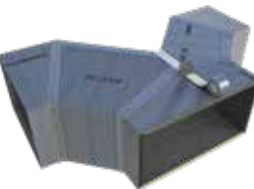

› STEP 4

It is sealed on the outside with **CLIMAVER® Aluminium Tape**, taping around the entire perimeter of the shape.

Triple dynamic branch

This is a shape that, starting with a main branch, produces a double branch or change of direction of the air laterally, reducing or enlarging the main section that continues.

A single bifurcation is made starting from the outer measurement of a straight section (Z), in which we know the flow and speed, and from that point we continue straight with an outer section (X) and we move laterally at 45° with two ducts with an outer measurement (Y) and (Y').

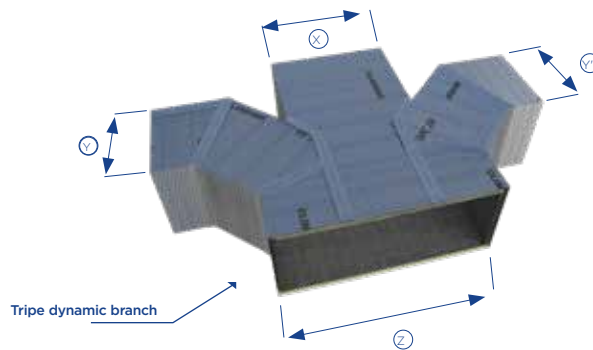

Video of triple dynamic branch production

To join the straight outlet section, exterior measurement (X) and the lateral branches of exterior measurements (Y) and (Y'), take into account the exterior section of the main duct, (Z) to achieve a geometric distribution of the difference in sections of the three ducts ($X+Y+Y'$) with respect to (Z).

For example, if the outer outlet sections of three ducts are $X=30$ cm in the straight section and $Y=20$ cm $Y'=20$ cm in the branches and we START with a main section of $Z=50$ cm, the measurement to be distributed is first calculated by adding the measurements of the outlet ducts, ($X=30$ cm + $Y=20$ cm + $Y'=20$ cm) and subtracting the measurement of the main duct ($Z=50$ cm). The resulting measurement (20 cm) is distributed geometrically among four parts (two parts (10 cm) correspond to one of the branches and the joint with the straight duct and the other two parts (10 cm) to the other branch and its joint with the straight duct).

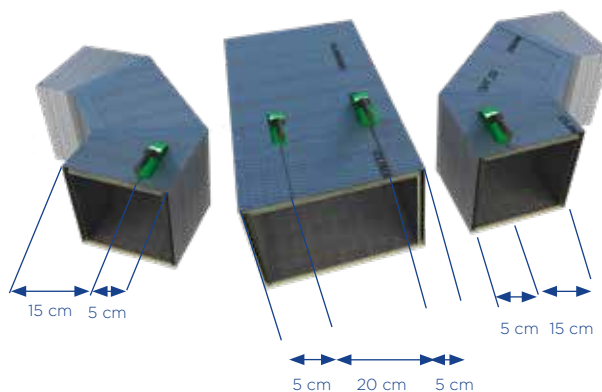

ALL LONGITUDINAL CUTS ARE MADE STRAIGHT AND SIDE CUTS ARE MADE AT 45°. TO FACILITATE ASSEMBLY AND GIVE MORE CONSISTENCY TO THE JOINTS, IT IS RECOMMENDED TO MAKE OVERLAPS IN SOME OF THE SHAPES, IN ADDITION TO SEALING THE JOINTS USING CLIMAVER® GLUE.

A triple dynamic branch is made as follows:



› STEP 1

Once the distribution is obtained, first transfer the measurements to one of the branches until the 45° outlet and then transfer the distribution measurement to the straight duct, projecting the intersection of the branch onto this measurement. Do exactly the same with the other branch.

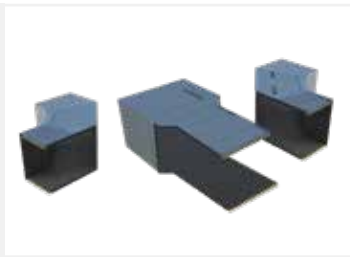

› STEP 2

To complete the layout, mark the entry of the branch at 45° above the point of intersection in the straight duct, since the bypass branch is inserted into the straight duct, avoiding the need to place baffles to divert the air. Repeat these steps on the other branch.



› STEP 3

Seal by applying a bead of **CLIMAVER® Glue** on the mineral wool surface of one of the pieces to be joined, next to the edge of the interior facing and completing the interior perimeter of the section.



› STEP 4

It is sealed on the outside with **CLIMAVER® Aluminium Tape**, taping around the entire perimeter of the shape.

«Shoe» lateral branching



Video of "shoe" lateral branching production

This is a shape that, starting with a main branch, produces a branch or change of air direction on one of its four faces and is generally used when the main section is larger than the lateral branch.

It is a very useful shape for connecting branches to a main branch that are lower in height or auxiliary elements of the installation, such as diffusers, grilles, plenums and flexible ducts.

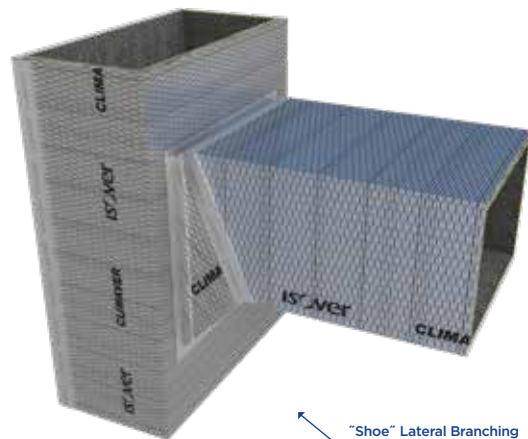

“Shoe” Lateral Branching



A lateral or “shoe” branching is made as follows:



› STEP 1

Make the lateral branch starting with a straight section and make two cuts in the same direction with the blade straight, one at 22.5° and the other at 45° (7 cm - 10 cm apart).



› STEP 2

Cut the adjoining sides marked with straight lines with the blade inclined at 22.5°, first orienting the blades in the direction of the angle previously obtained from the cuts of the straight blade.



› STEP 3

Turn the pieces obtained and seal with **CLIMAVER® Glue** and tape, so that the 45° side joins the main duct.



› STEP 4

Plot the base of the “shoe” shape on the main duct to mark the cutting area where the shape will be attached.

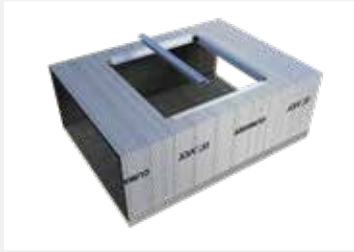

› STEP 5

Cut out the marked window and place Perfiver H on the perimeter so that the shoe shape rests completely on the wing of the profile.



› STEP 6

Seal the shoe shape and the main duct on the outside with CLIMAVER® Aluminium Tape.



REDUCTIONS

One-sided reduction (U+Cover)

This shape involves reducing one of its sides on one plane while maintaining the dimensions of the other side.

The reduction can be made concentrically, or by keeping one side straight and reducing the opposite, the latter being the most common on site and the method explained below.

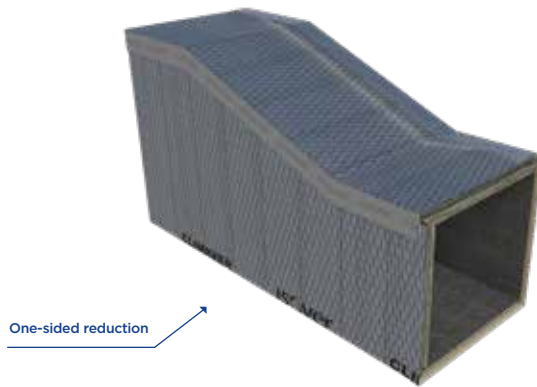

Video of a one-sided reduction production

To correctly connect the reduction to the ducts of the installation, it is recommended to leave a straight section with a "neck" of at least 7 cm - 10 cm at both ends of the duct so that the connection plane is straight. There are also many examples in which the panel remnants can be used; the one-sided reduction is not made in the width of the panel and these straight necks can be used in the machining of male and female elements.

Whenever possible, it is recommended to make progressive reductions to facilitate air flow circulation, reduce pressure losses and avoid acoustic increases. A 7-1 relationship between the reduction and its length is recommended, provided there is sufficient space.

For example, if there is going to be a 5 cm reduction, it is recommended to make the reduction along a 35 cm length.

Folding and forming the reduction



?

DID YOU KNOW?

Before plotting the reduction, it must be considered whether the ducts are discharge-return (discharge-reduce male side, return-reduce female side). For discharge, the duct section is reduced, advancing from the female to the male and, for return, in the opposite direction, following the direction of the air marked on the aluminium exterior complex.

To make a reduction on one side of a duct (a x b) and move to another with a lower section (c x b), proceed as follows:



› STEP 1

Mark longitudinally on the inside face of the **CLIMAVER®** panel two straight necks 7 cm - 10 cm at both ends of the duct.

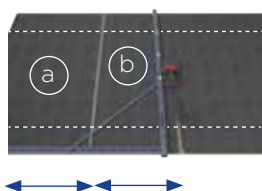

› STEP 2

To make the U, on which we are going to reduce the sides later, use the **CLIMAVER® Angle + Red Tool** to directly transfer the interior measurements of the duct. The first cut should be the largest measurement of the side to be reduced, and the second cut is made to the measurement of the side that remains constant and that will match the dimensions of the cover.

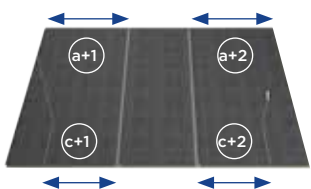

› STEP 3

Mark the reduction. From the cut of the red blade towards the outside, mark the reduction to be made on the male or female side depending on whether it is a discharge or return duct.

As it is a «U», in the fold the left side does not lose section and the right side loses 1 cm; when placing the cover with double flap both sides lose 1 cm on the sides of the «U»; for all this the reduction of the left side of the «U» should be supplemented with 1 cm to the interior measurement and the right side of the «U» should be supplemented with 2 cm to the interior measurement, as indicated in the image.

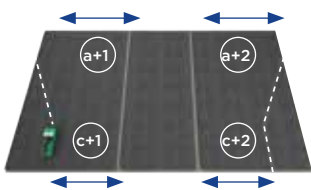

› STEP 4

The sides of the reduction are cut straight with the blade or straight blade.

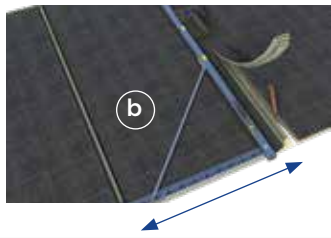

› STEP 5

To make the cover, pass the **Blue Tool** on both sides of it, always leaving the overlap on the outside, bearing in mind that if the angle guide is used, this gives + (1 cm) and it is necessary to subtract this from the interior measurement of the duct, and if the interior measurement is marked directly on the panel, pass the **Blue Blade** without the **Angle Guide** on both sides.



› STEP 6

To help with the folding and forming of the cover + U, make two cuts level with the straight necks previously marked, taking into account whether the folding is towards the inside or the outside, avoiding leaving open cuts inside the duct.



› STEP 7

Lastly, join the two pieces using **CLIMAVER® Staples** and **Aluminium Tape** to achieve the one-sided reduction.



Two-sided reduction: machine openings and outlets

In an installation there are shapes such as machine outlets and openings to diffusion elements, mainly in which there are reductions in both planes, with lateral displacements meaning that these cannot be made starting from a straight section. This shape involves reducing two of its sides in two planes; the most common way of making this shape is using the Traditional Covers method.



CLIMAVER® duct installation SDM two-sided reduction machine

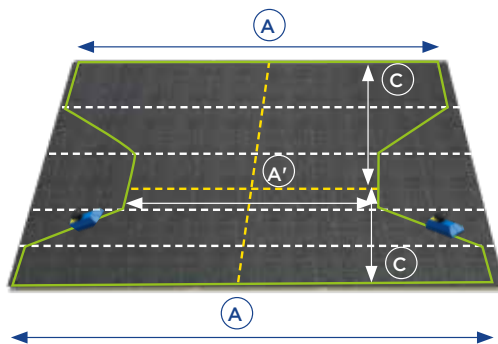

Example: 20 cm x 40 cm (top/bottom covers) to 20 cm x 15 cm (sides)

Lay out the first reduction of the upper and lower face with the dimensions A (40 cm) to A' (20 cm); first, draw the symmetry axes that delimit the length of the upper and lower covers and plot the distance C, length of the covers (50 cm) from the duct from side A to A'.

Next, from the axis of symmetry, draw two straight necks for each of the covers of approximately (7 - 10 cm) to be able to make the connection between the ducts in the horizontal plane and to be able to machine the males-females.

Lastly, plot the measurements of A (40 cm) and A' (20 cm) on the symmetry axes, leaving a reduction in the duct on the side that reduces by 20 cm (10 cm on each side of the centre of the duct).

To finish, make the overlaps on both sides by passing the blue blade on the outside of the marked line.

Make the surrounds by cutting straight with the knife with the interior measurement + 2 cm.

In the example, the second reduction of the sides of 20 cm changes to 22 cm and from 15 cm to 17 cm.

It is important to take into account the turns that the surrounds will make, as depending on these they will always require a longer length of panel.

Steps to follow for making a two-sided reduction:

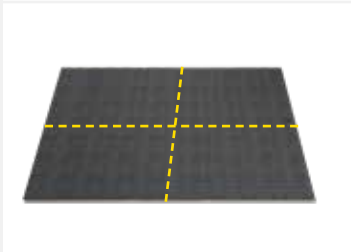

› STEP 1

Draw lines of symmetry to determine the top and bottom covers. Plot the distance from the duct to the grille on both sides of the axis.

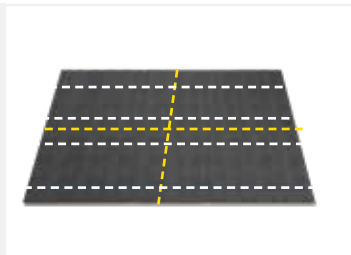

› STEP 2

Mark two straight necks to each of the covers; it is recommended to leave approximately 7-10 cm to be able to make males and females as appropriate later.

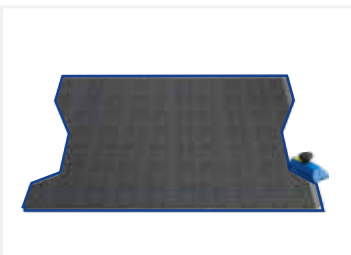

› STEP 3

Mark the reduction with the internal measurements of the duct; leave a minimum of 6 cm on both sides of the reductions to be able to pass the **Blue Tool** and obtain overlaps that always remain on the outside of the duct.



› STEP 4

Cut along the axis of symmetry to obtain the cover.



› STEP 5

Next, make the males and females to be able to connect the ducts.



› STEP 6

To make the side surrounds, take into account the two turns that the shape will make, as depending on how pronounced or gentle these turns are, more or less panel length will be required. The surrounds have straight collars at the same distance as the upper and lower covers and the straight sides are cut with the inner measurement (+2 cm).



› STEP 7

Staple and tape each of the pieces to obtain the desired shape.

DID YOU KNOW?

In many cases, in grille openings and machine outlets, the installation is located close to the ceiling. In such cases it is therefore recommended to leave the overlaps on the top and bottom so that the duct can be stapled and sealed.

AUXILIARY OPERATIONS

- › Connection to a machine and other metal frames
- › Connection to a grille
- › Connection to a diffuser
- › Access hatches

Connection to a machine AND OTHER METAL FRAMES

To connect a CLIMAVER® duct network in air conditioning-ventilation installations to all of its elements such as machines, sectioning gates, flow regulators, grilles, diffusers, inspection panels, etc., the use of accessories and auxiliary means that are detailed and developed below in this chapter are necessary.

The outlet of the conditioning equipment to the CLIMAVER® duct network is one of the critical points of the installation, due to both the air speed and the pressures that occur at this point. This is why it is necessary to ensure the correct fastening and airtightness of the installation at this point.

In high-flow and high-pressure machines, mechanical and integral fastening to the machine or to its anti-vibration strip is especially recommended using **PERFIVER H** or any other system that prevents the connection, once completely sealed with Aluminium Tape, from generating noise, vibrations and air leaks.



Opening and connection of CLIMAVER® duct network to a machine



Video of connection to a machine.

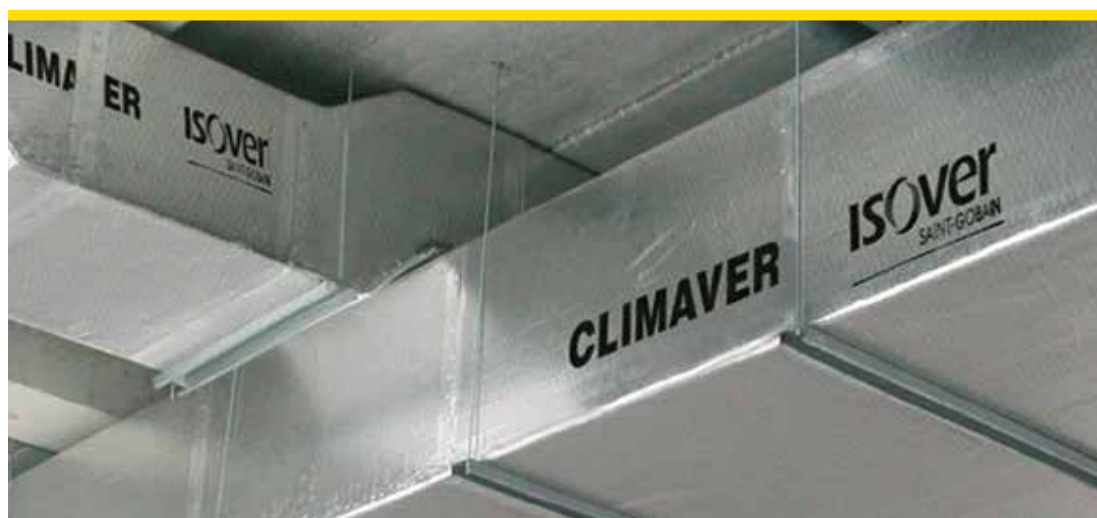

For connection to a machine and other metal frames, proceed as follows:



› STEP 1

Fastening to a machine or metal frame is carried out by joining the **PERFIVER H** overlap with the frame using mechanical fastenings.



› STEP 2

Introduce the edge of the **CLIMAVER®** panel into the perimeter mark created using **PERFIVER H**, fastening it on each of its sides with sheet metal screws or rivets through the profile and the metal frame. The number of fasteners depends on the length of the frame; place two fasteners close to the ends and space the rest of the fasteners approximately every 15 cm - 20 cm.



› STEP 3

Seal the perimeter of the joint with **CLIMAVER® Tape** to ensure the airtightness of the installation.

?





DID YOU KNOW?

Using Aluminium Tape to directly connect the **CLIMAVER®** duct with the metal frame in machines with a high flow and pressure without any type of profile or mechanical fastener does not guarantee the airtightness, durability or design conditions of the installation.



»» Design recommendations for the duct network at the machine outlet

It is recommended, wherever possible when connecting the ducts to a machine, to follow the instructions below to avoid additional pressure drops and additional turbulent regimes that reduce the performance of the installation:

- 
 The fan outlet must continue in a straight section of a length between 1.5 and 2.5 times the longest dimension of the fan mouth.
- 
 If reductions are made after the outlet, they must have a maximum inclination of 15° .
- 
 If an elbow needs to be made, the direction of air circulation inside it must match the rotation of the fan.
- 
 Connecting to the equipment using a coupling or flexible flange prevents the spread of vibrations.

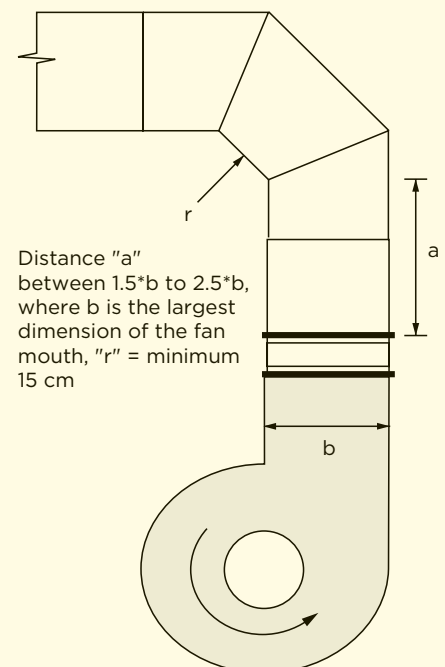

Connection TO A GRILLE

A network of ducts is usually connected to a diffusion element such as a grille through an outlet branch that connects the main duct with the diffusion element. The PERFIVER H is used to create perimeter marks for correctly connecting the outlet branch to both the main duct and the diffusion element, guaranteeing the mechanical fastening and airtightness of the joints.



DIAGRAM OF CONNECTION TO A DIFFUSION GRILLE

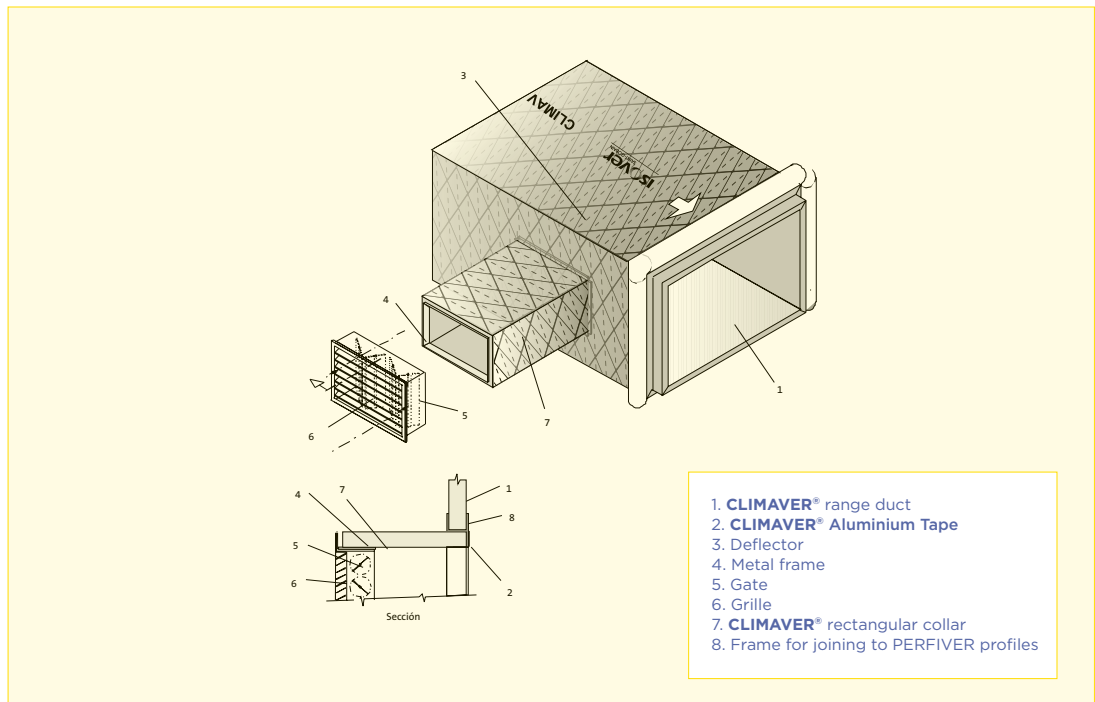

To connect a grille to a duct, it is recommended to proceed as follows:



› STEP 1

Draw and cut a window in the main duct with the dimensions of the branch to be inserted.

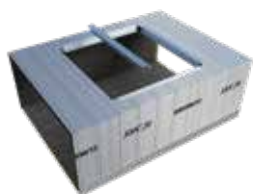

› STEP 2

Cut the **PERFIVER H** to the dimensions of the frame (it can be cut at 45° and 90°). Insert the Profile h on the edge of the window.



› STEP 3

Place the branch in the main duct, supporting this on the flange of the **PERFIVER H** previously installed and taping it to the main duct.



› STEP 4

Place the grille sub-frame in the **CLIMAVER®** duct and tape the duct from the inside, so that you can introduce the diffusion element frame from the room being conditioned by fitting it onto the sub-frame.

Connection TO A DIFFUSER

An Air Conditioning-Ventilation installation has diffusion elements of a circular geometry that, in order to be correctly connected to the main **CLIMAVER**[®] duct network, require additional accessories. To facilitate the exit of the air flow towards the diffusion element, it is recommended to insert the flexible element using the "shoe" shape (45° outlet) in the main branch.

For this purpose, ISOVER provides Flexible Ducts and Crown Sleeves in ten different diameters ranging from 102 mm to 406 mm.

-) **FLEXIVER CLIMA**, a flexible spiral duct with insulation and double polyester and aluminium sleeve (indicated for air conditioning installations).
-) **FLEXIVER D**, a flexible spiral duct with polyester and aluminium sleeve without insulation (indicated for ventilation installations).
-) **CROWN SLEEVE**, a galvanized sheet sleeve with claws that bend towards the inside of the duct to ensure that the flexible tube is joined to the main duct.



Video of connection
to a diffuser



CLIMAVER® duct installation. Connection to a diffuser using a flexible duct

?
**DID YOU
KNOW?**

Flexible ducts used for the connection of the network to the terminal units will be installed fully unfolded and with curves of radius equal to or greater than the nominal diameter. The length of each flexible connection must not be more than 1.5 m.

To connect a diffusion element using a flexible duct, proceed as follows.



› STEP 1

Once the lateral coupling or “Shoe” has been inserted into the main branch using a perimeter frame with **PERFIVER H**, place a cover on the end of the Shoe on which the perimeter of the **Crown Sleeve** will be marked and cut.

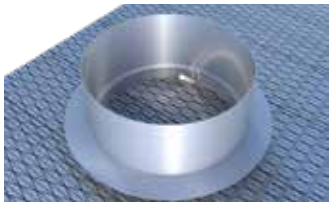

› STEP 2

In the cover of the Shoe, insert the **Crown sleeve** with the nails facing downwards, bending them towards the interior of the duct so that the thickness of the duct is flanged all around and fastened to it.

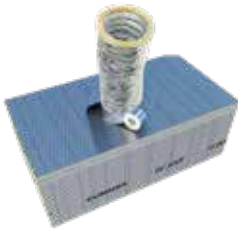

› STEP 3

Connect the flexible duct to the **Crown Sleeve**, sealing it with **CLIMAVER® Tape**.



› STEP 4

Connect the other end of the **FLEXIVER** to a plenum in which a **Crown Sleeve** has been previously connected or to the circular connection element of the diffusion element.

Access HATCHES

The existing regulation indicates the obligation to make access doors and registers in a network of air conditioning / ventilation ducts in order to carry out inspection, maintenance and cleaning operations of the facilities.

Access hatches must be installed in accordance with the provisions of the EN 12097 standard when there is:

- More than one modification of dimensions compared to the previous access hatch.
- More than one change of direction of more than 45° compared to the previous access hatch.
- More than 7.5 m of duct from the last access hatch.
- Removable elements that allow access to the installation, such as grilles and diffusers, are considered access hatches.

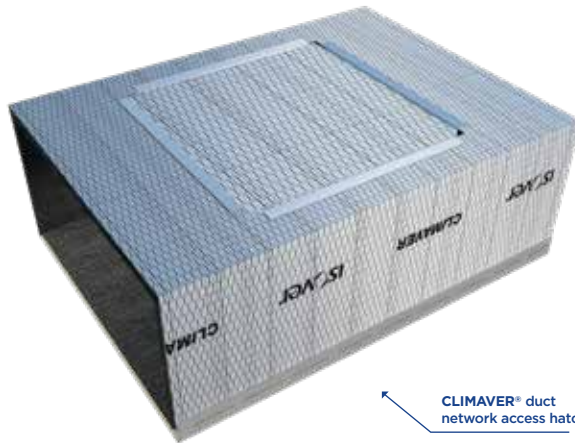

CLIMAVER® duct
network access hatch



Video of access
hatch creation



On the market there are different systems of access hatches and inspection panels for installation in the different types of ducts. In a **CLIMAVER**[®] duct network for air conditioning and ventilation, it is necessary to guarantee that the installation of inspection panels or access hatches does not affect the technical characteristics of the design of the installation and that these are maintained (airtightness, reaction to fire, thermal resistance, acoustics, etc.).

ISOVER has developed an easy-to-install system using the **PERFIVER H** aluminium profile, which allows inspection panels to be created in a **CLIMAVER**[®] duct installation, thereby guaranteeing the technical characteristics of the installation.

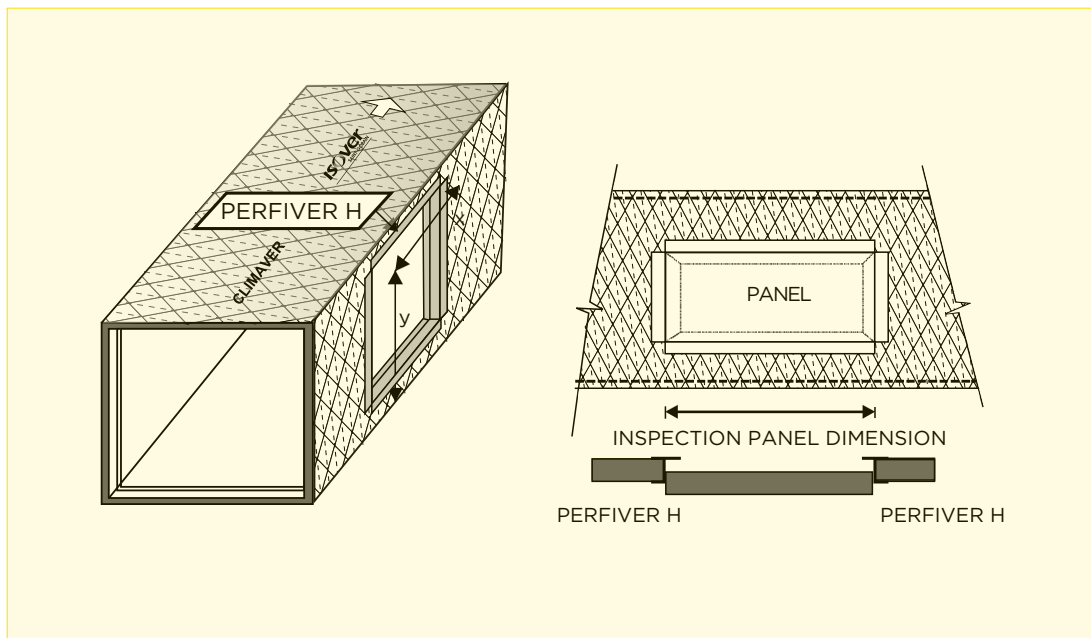

DID YOU KNOW?

Duct networks must be fitted with service openings in accordance with the indications of the EN 12097 standard to allow inspection, cleaning and disinfection operations.

To create an access hatch or inspection panel, proceed as follows.



› STEP 1

Plot the dimensions of the inspection panel on the duct.
Cut the marked window and remove it from the duct.



› STEP 2

Cut the **PERFIVER H** to the dimensions of the frame (it can be cut at 45° and 90°). Insert the H Profile on the edge of the window.



› STEP 3

Position the previously extracted window and externally tape the inspection panel cover with **CLIMAVER® Tape** to ensure airtightness.



REINFORCEMENTS AND SUPPORT

- › Reinforcements
- › Support

REINFORCEMENTS

The tests of mechanical resistance to pressure are carried out under European standard EN 13403.

CLIMAVER® ducts can be installed up to a maximum static pressure of 800 Pa. (positive and negative).

Two types of reinforcement systems are generally used, using threaded rod or continuous perimeter frames on the outside.

Reinforcements with threaded rods involve passing through the duct at its height and their USE IS NOT RECOMMENDED, especially if there are sides measuring more than 1,000 mm and/or high static pressures, since at no time do they create a continuous pressure distribution around the perimeter of the duct and can even cause overexertion in the planes not reinforced, causing deformations in the duct.

They also make it difficult to inspect and clean the duct on the inside, acoustics can be affected at these points and condensation can occur if they are not encapsulated correctly.

The reinforcements must be made using profiles, creating perimeter frames that in negative pressure are attached using mechanical fasteners (screw and washer/plate). During this process, it is recommended to reinforce the ducts before supporting them, essentially due to the ease and speed of execution on site and because the ducts can be supported from the reinforcement if this has been performed correctly.

In an air conditioning and ventilation installation, the support and reinforcement of the ducts, if necessary, are fundamental points that guarantee not only the correct operation of the installation as planned, but also ensure its durability by preventing the ducts from experiencing deformation, overstress, buckling, etc. for which they are not designed.

As the manufacturer of the entire range of **CLIMAVER®** solutions, ISOVER guarantees that its solutions are tried and tested in accredited laboratories in accordance with all current regulations and standards.

The distance between reinforcements is determined according to the design section of the duct, the maximum pressure of the air conditioner and the air flow, the aim always being to not reach the maximum deflection of its sides.

Through the correct operation of the installation, it must be guaranteed that excess pressures do not occur and that the design pressures of the installation are not exceeded in order to guarantee the correct operation of the installation.

In accordance with the actual working pressure of the installation and the dimensions of the duct, our recommendation regarding the perimeter reinforcement system is shown in the following table:

SIDE A OR B DIMENSION (MM)	WORKING PRESSURE (POSITIVE/NEGATIVE)			
	≤ 200 Pa	201 - 400 Pa	401 - 600 Pa	601 to 800 Pa
≤ 400	-	-	-	-
401-500	-	-	-	1200 mm
501-599	-	-	1200 mm	600 mm
600-750	-	1200 mm	600 mm	600 mm
751-899	1200 mm	1200 mm	600 mm	600 mm
900-1050	1200 mm	1200 mm	600 mm	600 mm
1051-1199	1200 mm	600 mm	600 mm	600 mm
1200-1499	600 mm	600 mm	400 mm	400 mm
≥ 1500	600 mm	600 mm	400 mm	400 mm

Tests carried out at CETIAT - Centre Technique des Industries Aérauliques et Thermiques n° 1415023. For installations with CLIMAVER® STAR, see reinforcement table included on page 81 of the Appendices. Saint-Gobain ISOVER bases its installation recommendations for the CLIMAVER® System on tests and certifications obtained by the corresponding bodies and professional laboratories. This table shows the mounting recommendations for a standard installation, not being binding.

Saint-Gobain ISOVER declines, except in cases of fraud or fraud directly attributable, any responsibility regarding its installation, the design of the latter, its start-up, etc... as the decision regarding the design, execution and start-up of the project corresponds to the professionals involved in the design and installation of the same.



In the corners, a joining square is attached to the rail to avoid separating the perpendicular sides from each other. The top and bottom of the rail must be long enough to cover the thickness of the side rails.

In both return ducts (negative pressure), the “Sandwich Type” joint of the perimeter reinforcement with the **CLIMAVER®** panel must be ensured. To achieve this, interior fasteners are used (plates or washers separated from each other (max. 400 mm) at sufficient intervals to meet the maximum deflection condition, using screws to perform the mechanical fastening with a dimension of approx 35 mm so that they can completely penetrate the 25 mm thickness of the **CLIMAVER®** panel, in addition to the thickness of the rail and plate.

In impulsion ducts (positive pressure), it must be adjust the perimeter frame to the duct as much as possible by outside to avoid the use of mechanical fixings between frame and **CLIMAVER®** duct.

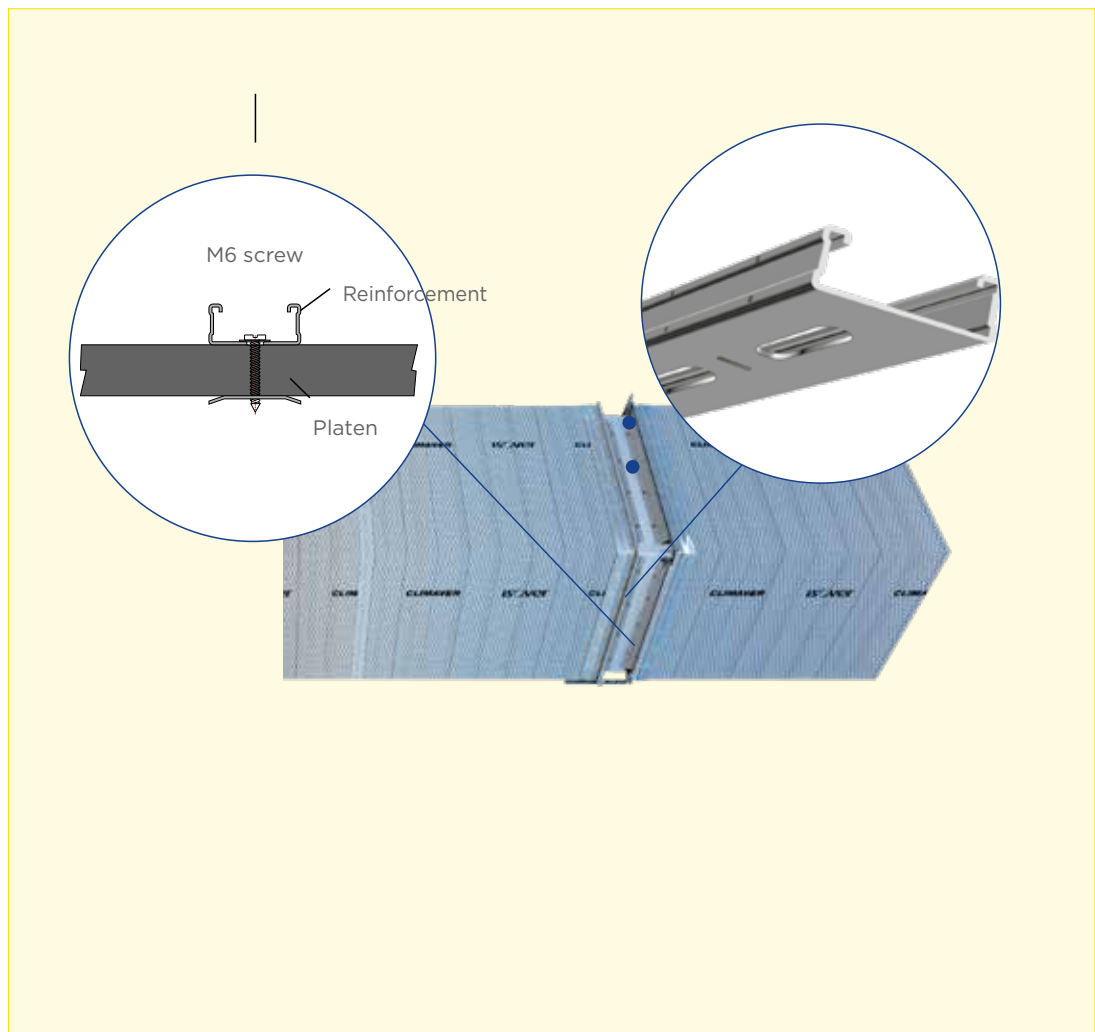

SUPPORT

Supports for Horizontal Ducts

The final installation of the ducts on the ceiling is performed using supports. The distance between supports is determined by the duct section according to the following table.

LARGER SIDE DIMENSION (MM)	MAXIMUM DISTANCE BETWEEN SUPPORTS (M)
< 900	2.40
900 TO 1,500	1.80
> 1,500	1.20

When the internal perimeter of the duct is less than 2 m and does not have reinforcements, there can be up to two transverse joints between supports.



Support for CLIMAVER® A2 DECO ventilation installation



The most common way to support the ducts is to use a horizontal "U" profile with the dimensions 15 mm x 25 mm made from a galvanised sheet 0.8 mm thick.



This "U" profile is fastened to the ceiling using two threaded rods; a minimum of 4 mm metric threaded rods are used.



When the duct is reinforced, it is best for the support to match up with the reinforcement, as long as the maximum distance according to the previous table is observed. In this case, the vertical elements of the support will be joined to the reinforcement frame using two plates and screws.

It is also possible to use a gripple cable suspension system, the distance between them being the same as that used by means of a profile. It is recommended to install protective corner pieces at points where the cable can damage or perforate the aluminium outer complex that acts as a vapour barrier.

Supports for Vertical Ducts

As the manufacturer of the **CLIMAVER®** solution, ISOVER recommends, in order to standardise its solutions, the installation of supports in vertical ducts as indicated below

The vertical supports are placed at a maximum distance of 3 m.

- When the duct is supported on a vertical wall, the anchor is recommended to coincide with one of the perimeter rail frames for reinforcement if needed.
- The support is made with a minimum angle profile of 30 x 30 x 3 mm.

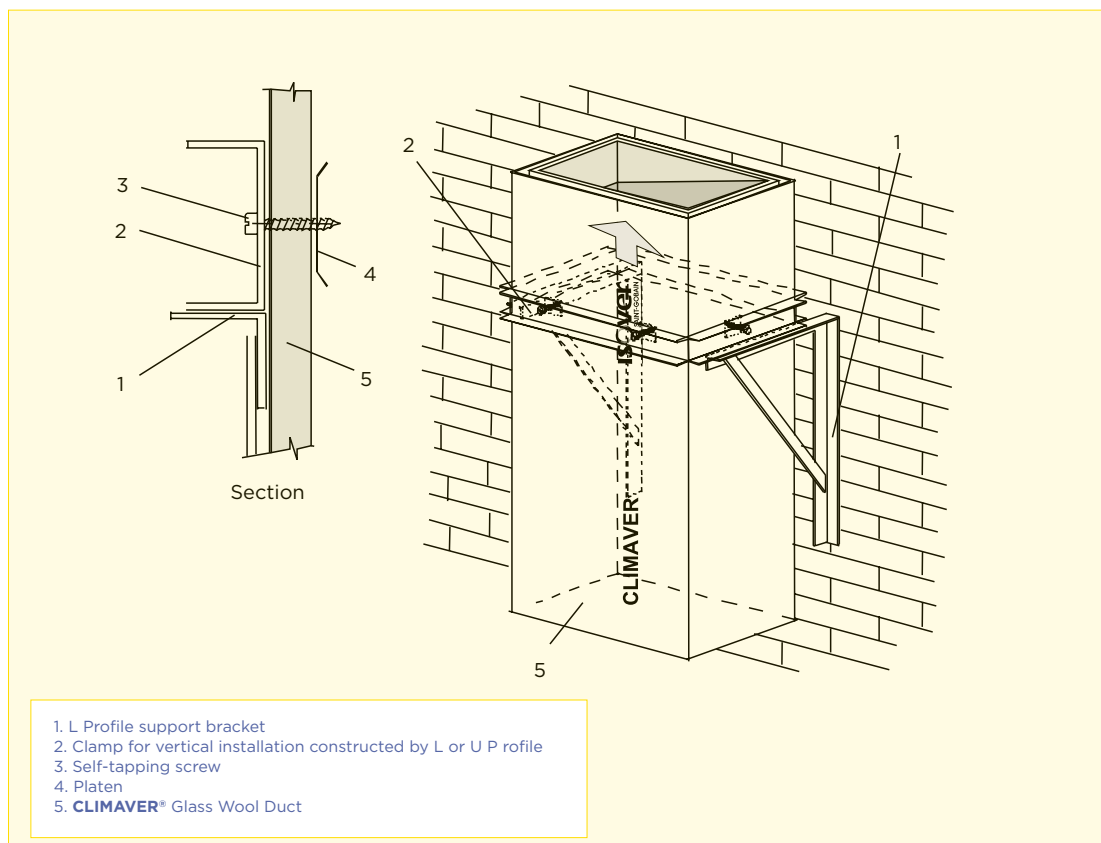

Depending on their experience, professionalism and the conditions present in the installation (dimensions, slab steps, heights, etc.), installers can suggest other solutions that, although not covered in this Installation Guide, give the duct network the necessary stability, support and resistance to ensure that **CLIMAVER®** ducts can be installed to guarantee the protection, resistance and sealing conditions defined in the project.

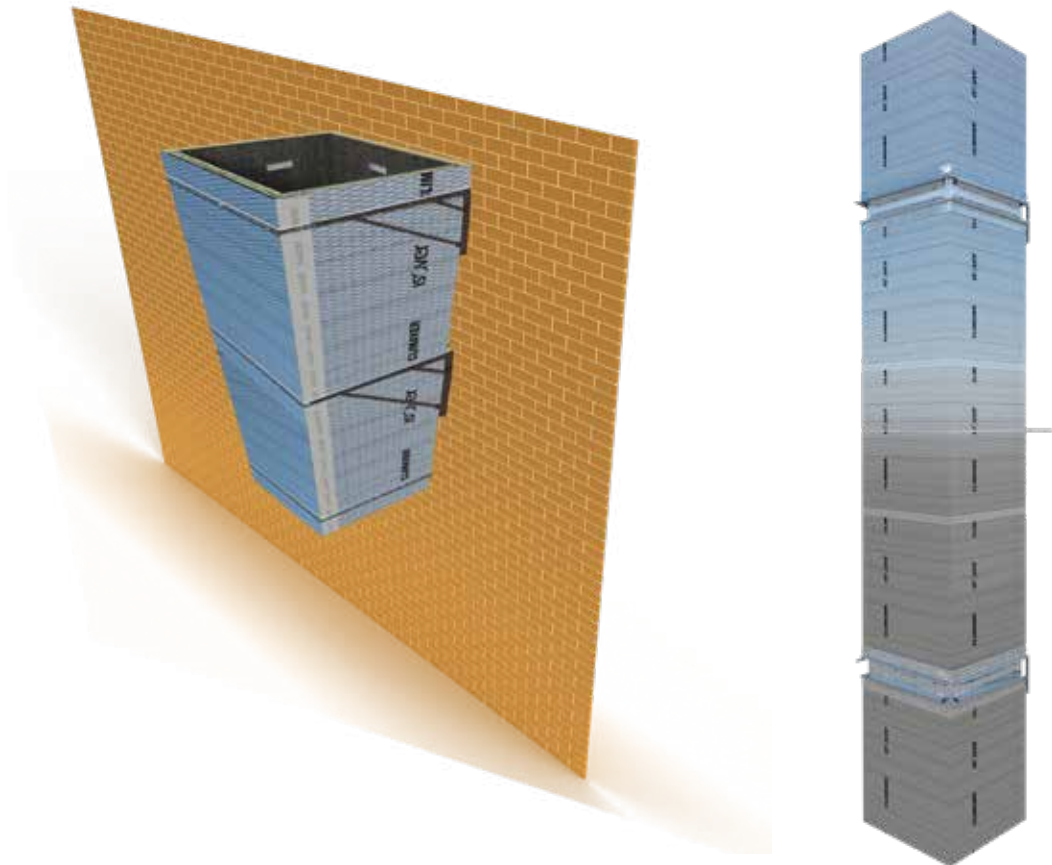

APPENDICES

- › **CLIMAVER**[®] METAL system
- › **CLIMAVER**[®] STAR assembly system
- › Pressure losses in **CLIMAVER**[®] ducts
- › Measurements in installations
- › Application restrictions
- › Waste management
- › Cleaning **CLIMAVER**[®] ducts
- › Panel development in straight sections table
- › **CLIMAVER**[®] technical data sheets

CLIMAVER® METAL SYSTEM

The **CLIMAVER®** range is tested and certified to guarantee the proper preservation of the installations, allowing the inspection and cleaning of the installation with the approved equipment and systems (mechanical and suction equipment) for the air conditioning and ventilation ducts.

The entire **CLIMAVER®** range can be used to create a network of sealed and perfectly rigid ducts, since it has a class R2 stiffness according to EN 13403.

For installations that require a greater number of cleaning cycles than the 20 tested cleaning cycles or the use of robots or maintenance machines of greater weight and dimensions, or when higher performance is needed in the installation as is the case with ducts of a large section, the **CLIMAVER® METAL System** is recommended, installing profiles that are specially indicated for reinforcing and covering the internal longitudinal joints of the ducts.

In the **CLIMAVER® METAL System**, the ducts hardly gain any weight due to the inclusion of the aluminium profiles (400 grams), meaning it is not necessary to modify the supports or installation distances described in this manual.

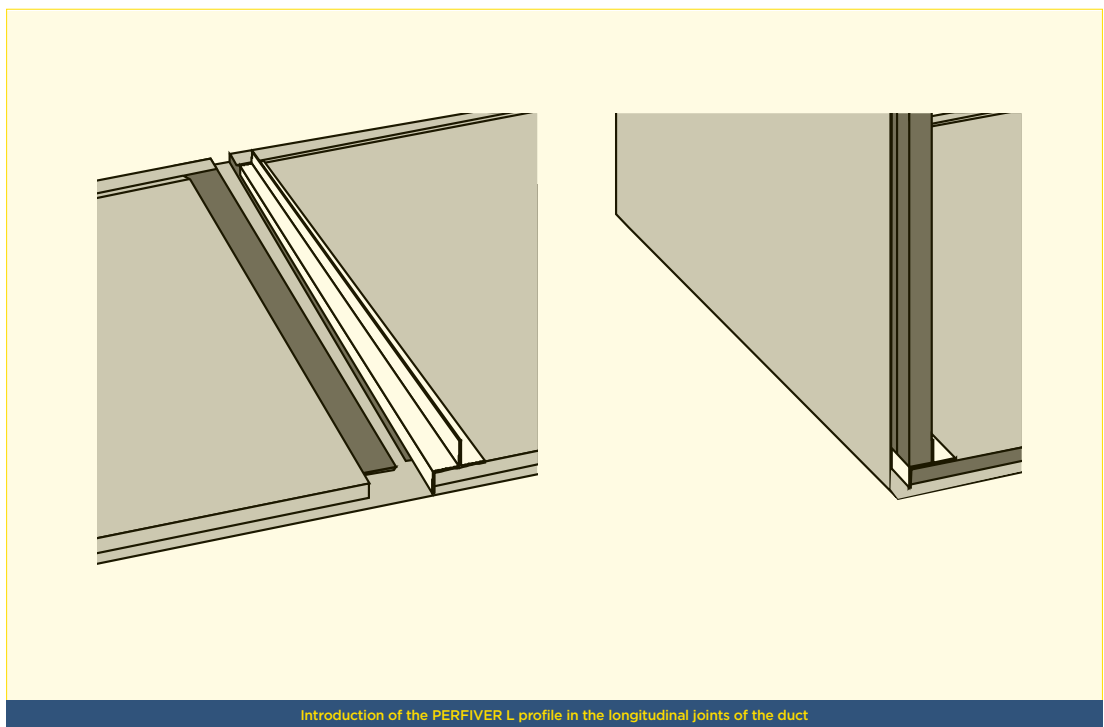

The **CLIMAVER® METAL System** can be applied to all panels in the **CLIMAVER®** range. Its use is not mandatory and it is made up of two types of aluminium metal profiles.

- PERFIVER L:** This is placed in the longitudinal half-lap joints of the **CLIMAVER®** ducts. The 1,155 m long **PERFIVER L** metal profile serves to reinforce and protect the interior longitudinal joint of the **CLIMAVER®** duct.

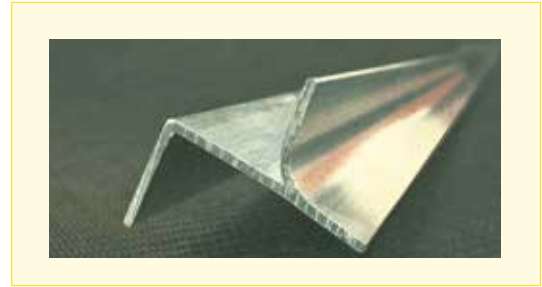

- PERFIVER H:** This is used to guarantee the tightness and final finish in the **CLIMAVER®** duct joints with terminal elements such as a machine outlet, cleaning inspection panels and diffusion element openings. It is also possible to use the **PERFIVER H** in large section ducts as perimeter reinforcements, both in straight sections and in shapes made using the Straight Duct Method. It can also be used in connections to a metal duct and between products from the **CLIMAVER®** range of different thicknesses.



CLIMAVER® STAR ASSEMBLY SYSTEM

Description

Panel for making self-supporting ducts valid for installations outside buildings with an exclusive external facing with high mechanical resistance and protection from ultraviolet rays. Also featuring a net interior lining with high acoustic absorption.

Applications

CLIMAVER® STAR is suitable for pressures of up to 800 Pa. With a thickness of 40 mm with a conductivity of 0.032 W / (m · k) at 10°C, it has the thermal resistance required for the exterior of buildings.

CLIMAVER® STAR Tape is used to seal the longitudinal and perimeter joints, being made with the same facing as the panel itself.

This product has the same advantages and ease of installation as the rest of the panels in the **CLIMAVER®** range, since it is installed using the same working methods, adapting easily to the needs of the installation.

To make longitudinal cuts, the **CLIMAVER® APTA Blades** or **CLIMAVER® Universal Tools** are used.

As the manufacturer of the **CLIMAVER® STAR** solution, ISOVER includes all of its installation recommendations in the **CLIMAVER® STAR** Installation Manual.

For the installation of **CLIMAVER® STAR**, ISOVER recommends the use of continuous perimeter frame reinforcements, the maximum distances of the reinforcement being the same for discharge as for return (see reference table in this appendix).

The method to use for making the continuous perimeter frames is a perforated rail (1.2 mm/2 mm thick), depending on the sections and maximum working pressures of the air conditioners, air handling units, recovery units, machines, etc.



CLIMAVER® STAR
installation manual



CLIMAVER® STAR duct installation

SIDE INTERIOR DIMENSION A OR B (MM)	MAXIMIM STATIC PRESSURE (Positive/Negative)			
	≤ 200 Pa	201 - 400 Pa	401 - 600 Pa	601 - 800 Pa
LESS THAN 500	-	-	-	-
1,400 TO 599	-	-	1,200 mm	600 mm
600 TO 699	-	1,200 mm	600 mm	600 mm
700 TO 799	1,200 mm	1,200 mm	600 mm	600 mm
800 TO 999	1,200 mm	600 mm	600 mm	600 mm
1,000 TO 1,099	1,200 mm	600 mm	600 mm	400 mm
1,100 TO 1,399	600 mm	600 mm	400 mm	400 mm
1,400 TO 2,000	600 mm	600 mm	400 mm	400 mm

- 1.2 mm perforated rail
- 2.0 mm perforated rail
- Without reinforcement

? DID YOU KNOW?

Wherever possible in CLIMAVER® STAR installations, it is recommended to place the perimeter reinforcements on the male and female joints.

Pressure losses IN CLIMAVER® DUCTS

The self-supporting air conditioning and ventilation ducts made from mineral wool panels cause slightly lower load losses in elbows and branchings, or at most similar when made using straight 45° sections compared to making the shape using curved sections.

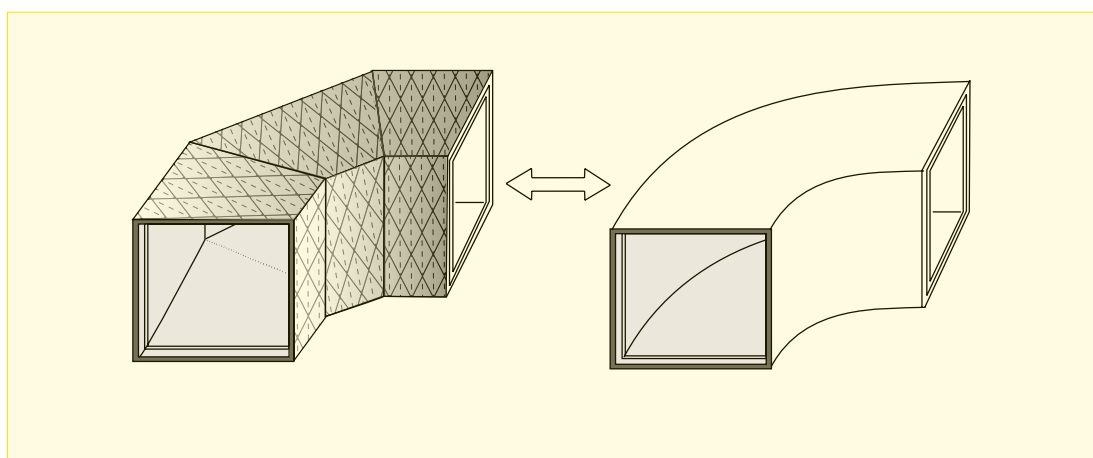

Purpose

Comparative analysis of pressure drops between the two most common systems for linking shapes for duct networks made from glass wool panels, covered on the inside with aluminium sheet (CLIMAVER® PLUS R).

Background

The most traditional duct production system, commonly referred to as the “covers” system, allows duct networks to be created with elbows and curved surface enclosure shapes.

The drawback of this system is that the quality of the shapes, and especially of the elbows, as the simplest and most common shape, is highly dependent on the operator’s capabilities, and in any case the internal surfaces of the piece have a high number of internal cuts and therefore joints.

If they are not correctly executed, these joints can create areas in which dirt accumulates and the shapes are weakened.

This study aims to assess the pressure losses, taking into account, among other factors, the possible influence on air friction from correctly made interior joints.

Saint-Gobain ISOVER Ibérica, S.L. has developed a complete assembly methodology based on the production of shapes and, therefore, of elbows from straight ducts, called the Straight Duct Method (SDM.). One of the main and differentiating characteristics of the **CLIMAVER®** exterior complex, compared to other solutions on the market, is its patented guide marking with lines at 22.5° (SDM MARKING) to facilitate and optimise the installer's work.

The elements necessary to make deviations in the air distribution at a 90° angle are produced using this method by means of two 45° changes of direction separated by a minimum distance of 15 cm.

There is no appreciable difference in pressure drop, as there are favourable considerations for the new system in this respect (lower surface roughness due to having fewer cuts). The latter was supported by the experiences of calculation engineers consulted on actual works.

To confirm all of the above, a decision was made to conduct the evaluation test that has resulted in this report.



CLIMAVER® A2 DECO duct installation

Test

»» ASSEMBLY

Assemblies with an equal geometry of **CLIMAVER® PLUS R** ducts were built, connected to the outlet of a centrifugal fan with a variable speed motor, capable of producing at most 8 m³/s, with a pressure of 110 mm c.a.

The test conditions were as follows:

- The assemblies consisted of a straight section + an elbow + a straight section.
- The straight sections were one metre in length greater than six diameters of the circular section equivalent to the rectangular ducts.

The equivalent diameter of a rectangular duct of section a x b is given by the algorithm:

$$De = 1.3 \frac{(a \cdot b)^{0.625}}{(a + b)^{0.251}}$$

- The test lines were constructed with two sections of 300 x 300 mm and 390 x 310 mm. For each section, two types of elbows were built: curved and three-piece, taking care to ensure that the longitudinal developments of the elbows were the same for each section of the duct.
- The air circulation speed was determined by an anemometer located downstream of the elbows, at six equivalent diameters from their straight outlet + 0.5 m.
- The pressure drop in the system was determined using a pitot tube, placing the collectors 1 m before the elbows and, downstream from the elbows, at six equivalent diameters from their straight outlet.

The assembly is shown in the attached diagrams.

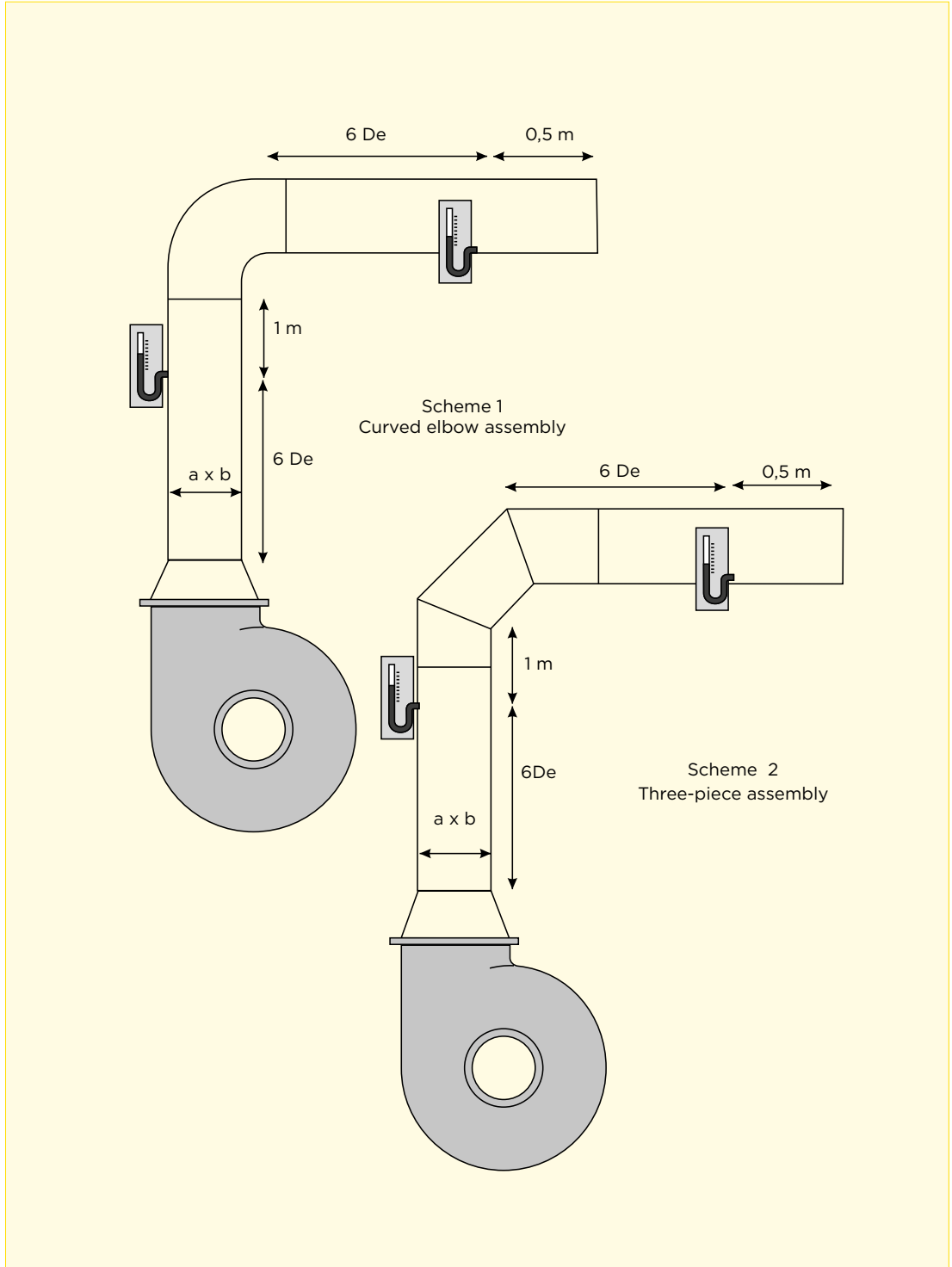

Test results

The attached table (Table 1) shows the actual measurements obtained in the tests.

The results can be extended to the full spectrum of speeds by adjusting the actual values to the theoretical values, according to:

$$\Delta P = C * K_{RE} * s^2/4$$

where:

- The coefficient “C” is a function of the geometry of the elbow (section and shape);
- The value of “KRe” depends on Re, but tends to 1 for values of $s > 5.5$ m/s, for the test sections.

In summary: a sufficient approximation for the pressure losses can be established with a parabolic curve of the shape:

$$\Delta P = K_i * v^2$$

With K_i values different for each geometry, obtained as an average of results applying the actual test values.

SPEED M / S	ACTUAL PRESSURE LOSSES ΔP (MM C.A.)			
	Round Elbow 390 mm x 310 mm	3 piece elbow 390 mm x 310 mm	Round elbow 300 mm x 300 mm	3 piece elbow 300 mm x 300 mm
7	2	1.5	1	1
14	8.5	-	-	5
15	-	8.5	6	-
20	20	-	-	-
22	-	20	15	13

Table 1.

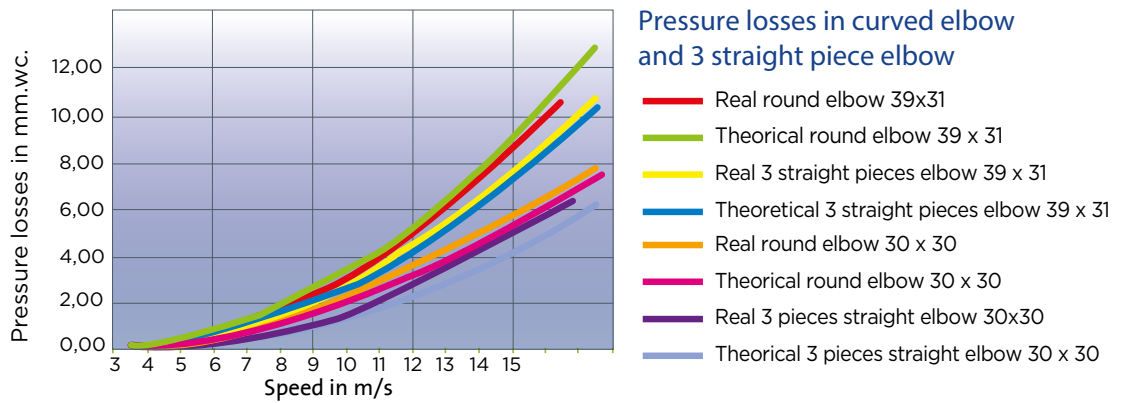

This all gives us Table 2.

SPEED m / s	ACTUAL PRESSURE LOSSES ΔP (MM C.A.)			
	Round Elbow 390 mm x 310 mm	3 piece elbow 390 mm x 310 mm	Round elbow 300 mm x 300 mm	3 piece elbow 300 mm x 300 mm
1	0.05	0.04	0.03	0.02
2	0.18	0.15	0.10	0.10
3	0.41	0.33	0.23	0.22
4	0.74	0.59	0.42	0.38
5	1.15	0.93	0.65	0.60
6	1.66	1.33	0.94	0.86
7	2.25	1.81	1.27	1.18
8	2.94	2.37	1.66	1.54
9	3.73	3.00	2.11	1.94
10	4.60	3.70	2.60	2.40
11	5.57	4.48	3.15	2.90
12	6.62	5.33	3.74	3.46
13	7.77	6.25	4.39	4.06
14	9.02	7.25	5.10	4.70
15	10.35	8.33	5.85	5.40
16	11.78	9.47	6.66	6.14
17	13.29	10.69	7.51	6.94
18	14.90	11.99	8.42	7.78
19	16.61	13.36	9.39	8.66
20	18.40	14.80	10.40	9.60
21	20.29	16.32	11.47	10.58
22	22.26	17.91	12.58	11.62

?

**DID YOU
KNOW?**

The pressure loss calculations performed by the computer programs for shapes with curved surfaces (exterior and interior enclosures) are applicable for the assembly of duct networks constructed according to the straight duct method, without the need for adjustments.



Conclusions:

From the above results, it can be concluded:

- a) For the same geometry, the three-piece elbows (two 45° deviations) have less pressure loss with circular or curved surface enclosures.
- b) The differences between both elbow systems are insignificant for speed values < 7 M/S.

Measurements IN INSTALLATIONS

Measurements in installations with CLIMAVER® ducts

Using the Straight Duct Method, it is extremely easy to take the appropriate measurements to fit the intended design of the installation. This statement will be demonstrated using an example.

Imagine an installation in which we need to create an elbow and continue along the wall.

From the end of the duct to the wall there are 22 cm to go. These 22 cm will be gained with the elbow that will be made to adjust to the change in direction.

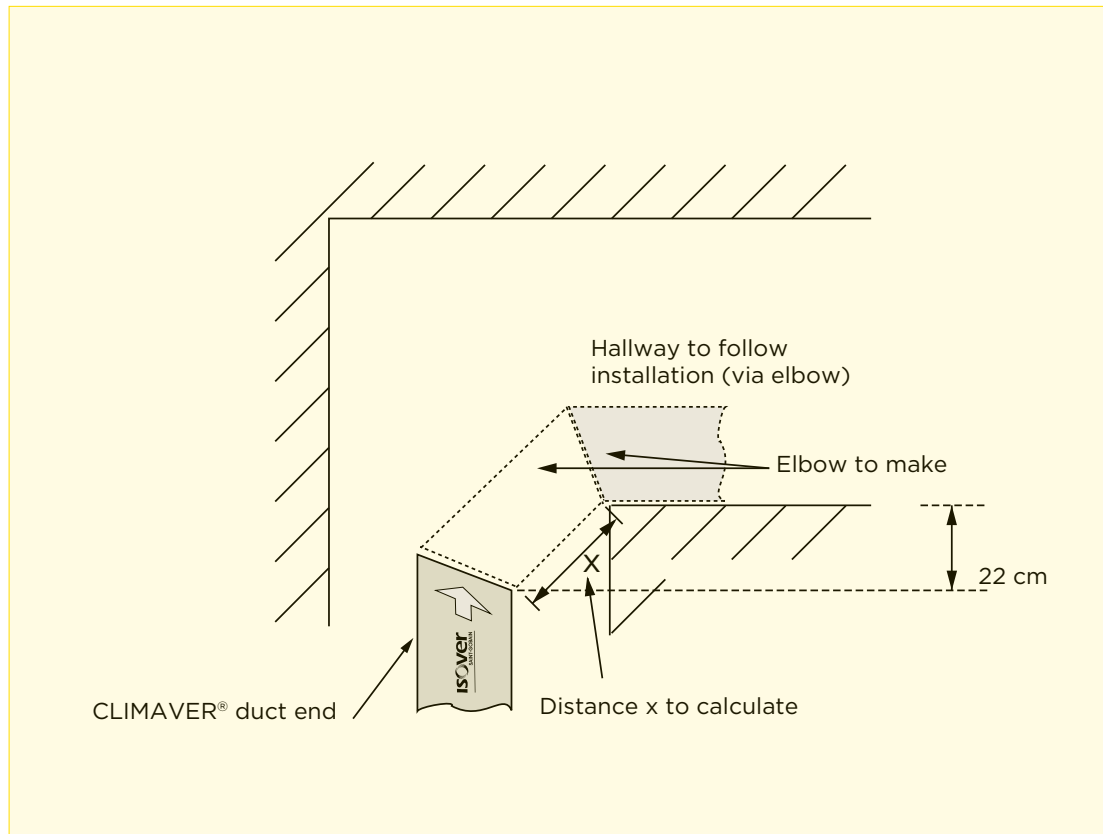

In a standard elbow, for every 15 cm that we separate the two cuts at 22.5° (according to the guidelines), we gain 11 cm in height.

Thus, using a simple rule of three, to get 22 cm we need to separate the two cuts at 22.5° , 30 cm.

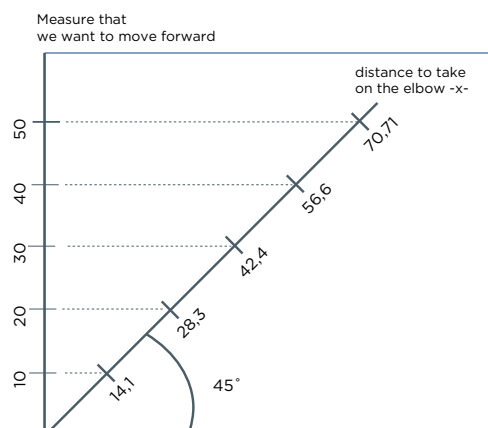
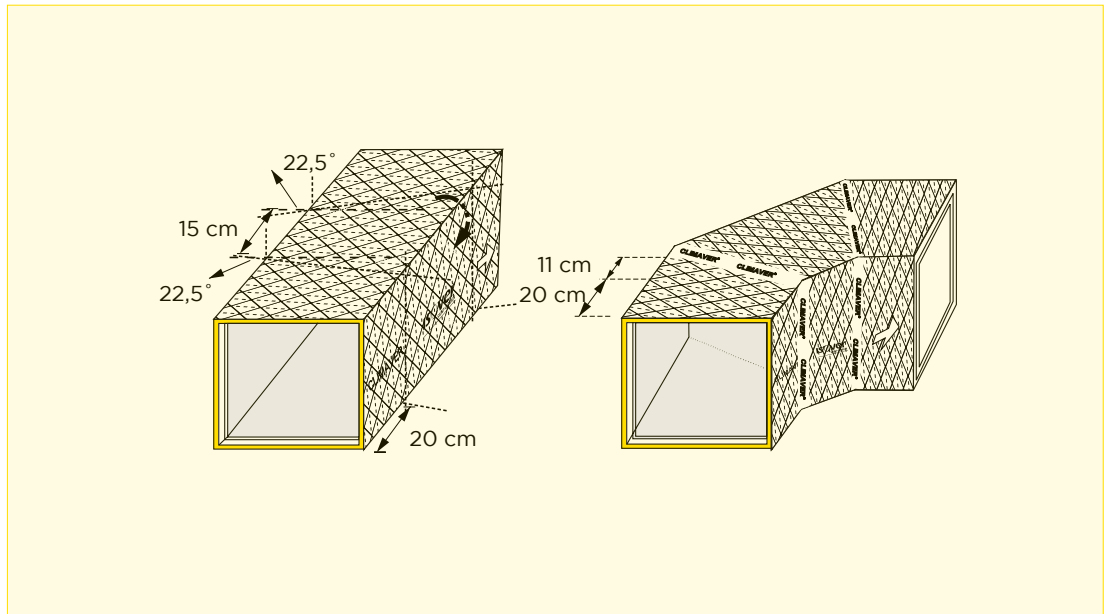

FOR DISTANCES WHERE IT IS NOT SO EASY TO USE A RULE OF THREE, IT IS MUCH EASIER TO DRAW A SMALL TEMPLATE LIKE THE ONE ATTACHED.

Application RESTRICTIONS

By Regulations

According to the EN 13403 Standard, in section 5 “Application restrictions”, glass wool ducts cannot be used for:

- ⌋ Extraction ducts from hoods or smoke cabinets (kitchens, laboratories, etc.).
- ⌋ Air extraction ducts containing corrosive gases or suspended solids.
- ⌋ Ducts installed outside buildings, without additional protection, except **CLIMAVER® STAR**.
- ⌋ Buried ducts, without additional protection.
- ⌋ Vertical ducts more than 10 m high, without additional supports.
- ⌋ Chlorine-saturated environments.

CLIMAVER® ducts should not be used when the following application limits are exceeded:

- ⌋ Maximum static pressure: 800 Pa.
- ⌋ Maximum speed: 18 m/s.
- ⌋ Maximum air temperature: 60°C outside the duct and 90°C inside.
- ⌋ Minimum temperature: -30°C.

Aluminium Tapes that do not meet the following requirements must not be used:

- ⌋ The nominal minimum width of the tape must be 63 mm.
- ⌋ The tensile strength must be equal to or greater than 45 N/cm.
- ⌋ The separation resistance must be at least 6.7 N/cm at 82°C and after 15 min. of test.



Manufacturer recommendations

- Internal cuts should not be made on the panel without sealing using **CLIMAVER® Glue** or **Tape** on the sharp edges.
- Curved elbows should not be made, as interior cuts need to be made in the panel in order to bend and adjust the panel to the shape of the elbow.
- The fan outlet must continue in a straight section of a length between 1.5 and 2.5 times the longest dimension of the fan mouth.
- If reductions are made after the outlet, they must have a maximum inclination of 15°.
- If an elbow must be made, the direction of air circulation in it must match to the rotation of the fan.
- The connection to the equipment must be adjusted by inserting a flexible coupling to prevent the spread of vibrations.
- The Aluminium Tape used must be at least 65 mm wide and 50 microns thick.

Lastly, and depending on the relative position of the equipment flange and the air duct, it may be necessary to have a sheet metal angle to reaffirm the connection. As can be seen, the different arrangements use a screw to secure the fastening between the **PERFIVER H** and the panel. Another aspect to consider is that the panel should not be inserted into the air outlet of the machine.

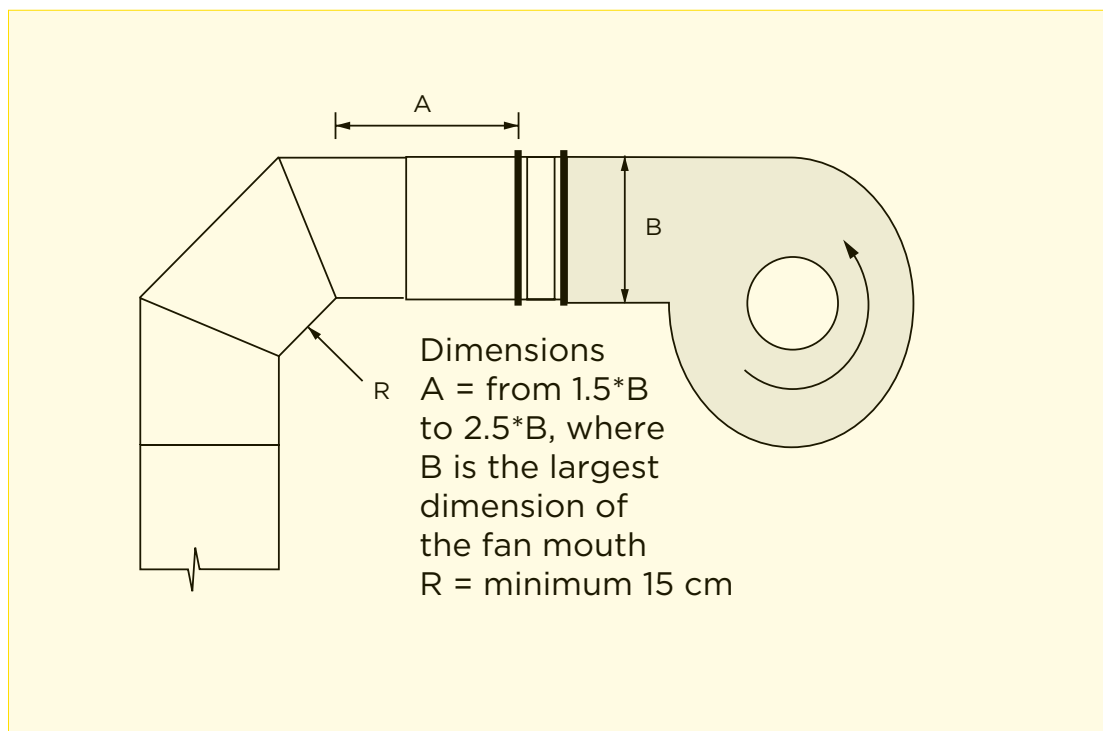

Waste MANAGEMENT

All of the products manufactured by Saint-Gobain ISOVER Iberica, S.L., in Azuqueca de Henares are certified by the EUCEB European Certification Board of Mineral Wool Products - www.euceb.org, a voluntary initiative for the mineral wool industry. This is an independent certification body that guarantees that products are made from fibres meeting the criteria for carcinogenicity exemption (Note Q) of Directive 97/69/EC and Regulation (EC) 1272/2008

According to law 22/2011, order MAM 304/2002 and order AAA/661/2013, of 18 April, amending appendices I, II and III of Royal Decree 1481/2001 of 27 December through which the operations of waste recovery and disposal in landfills are published and through which the European Waste list is approved, mineral wool is classified under the code 170604 NON-HAZARDOUS Insulating Materials from Construction and Demolition Works.

Saint-Gobain ISOVER Ibérica has a characterisation report produced by a laboratory accredited by ENAC number RE-18/001450. M1. The analyses were performed in testing laboratories accredited by ENAC with accreditation number 286/LE486.

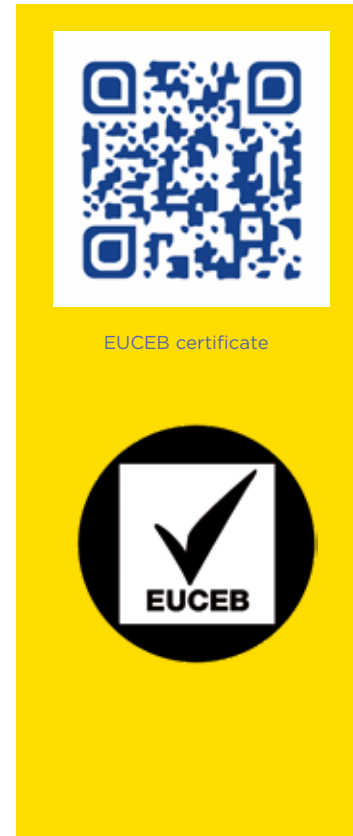

DID YOU KNOW?

The residues of ISOVER mineral wool products should be considered «non-hazardous waste» and can therefore be taken directly to landfill. This waste is included in the CER 170604 Code: «Insulation materials other than those specified in the codes: 170601 and 170603», and are completely free from asbestos.

CLIMAVER® DUCT CLEANING

The inner facing of the ducts is resistant to the aggressive action of disinfection products, and its inner surface will have a mechanical resistance that allows it to withstand the stresses to which it will be subjected during mechanical cleaning operations.

Likewise, the Standard EN 13403 (Ventilation of buildings, non-metallic ducts. Insulating Material Sheet Duct Network) states that the sheets must withstand cleaning operations equivalent to a life cycle of 20 years' use (one cleaning operation per year) without any damage. After testing the 20 cleaning simulations, the material on the inner surface of the duct should not flake off or show evidence of erosion or delamination.

In the CETIAT 1014160 reported test, it is indicated that the erosion and emission of particles from the **CLIMAVER®** ducts after 20 cleaning cycles are in accordance with that indicated in the EN 13403 Standard

Likewise, ISOVER states that together with manufacturers of inspection and cleaning equipment and systems, **CLIMAVER®** ducts have been tested to carry out several inspection and cleaning tests in our facilities with a completely satisfactory result.

? DID YOU KNOW?

All ducts in the **CLIMAVER®** range are cleanable by the most standardized interior cleaning methods (such as mechanical brushing, pressure cleaning and vacuuming).

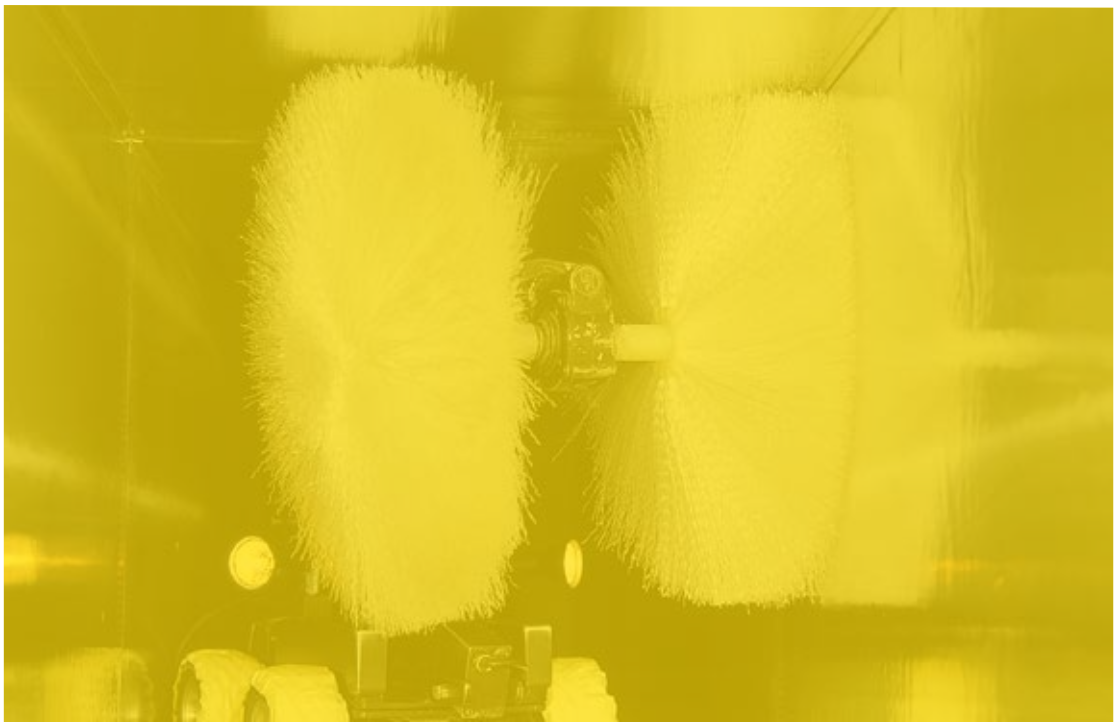

Panel development IN STRAIGHT SECTIONS TABLE

Straight section in a 25 mm CLIMAVER® piece

A/B	10	15	20	25	30	35	40	45	50	55	60	65	70	75	80	85	90	95	100	105	110	115	120	125	130
10	60	70	80	90	100	110	120	130	140	150	160	170	180	190	200	210	220	230	240	250	260	270	280	290	300
15	70	80	90	100	110	120	130	140	150	160	170	180	190	200	210	220	230	240	250	260	270	280	290	300	-
20	80	90	100	110	120	130	140	150	160	170	180	190	200	210	220	230	240	250	260	270	280	290	300	-	-
25	90	100	110	120	130	140	150	160	170	180	190	200	210	220	230	240	250	260	270	280	290	300	-	-	-
30	100	110	120	130	140	150	160	170	180	190	200	210	220	230	240	250	260	270	280	290	300	-	-	-	-
35	110	120	130	140	150	160	170	180	190	200	210	220	230	240	250	260	270	280	290	300	-	-	-	-	-
40	120	130	140	150	160	170	180	190	200	210	220	230	240	250	260	270	280	290	300	-	-	-	-	-	-
45	130	140	150	160	170	180	190	200	210	220	230	240	250	260	270	280	290	300	-	-	-	-	-	-	-
50	140	150	160	170	180	190	200	210	220	230	240	250	260	270	280	290	300	-	-	-	-	-	-	-	-
55	150	160	170	180	190	200	210	220	230	240	250	260	270	280	290	300	-	-	-	-	-	-	-	-	-
60	160	170	180	190	200	210	220	230	240	250	260	270	280	290	300	-	-	-	-	-	-	-	-	-	-
65	170	180	190	200	210	220	230	240	250	260	270	280	290	300	-	-	-	-	-	-	-	-	-	-	-
70	180	190	200	210	220	230	240	250	260	270	280	290	300	-	-	-	-	-	-	-	-	-	-	-	-
75	190	200	210	220	230	240	250	260	270	280	290	300	-	-	-	-	-	-	-	-	-	-	-	-	-
80	200	210	220	230	240	250	260	270	280	290	300	-	-	-	-	-	-	-	-	-	-	-	-	-	-
85	210	220	230	240	250	260	270	280	290	300	-	-	-	-	-	-	-	-	-	-	-	-	-	-	-
90	220	230	240	250	260	270	280	290	300	-	-	-	-	-	-	-	-	-	-	-	-	-	-	-	-
95	230	240	250	260	270	280	290	300	-	-	-	-	-	-	-	-	-	-	-	-	-	-	-	-	-
100	240	250	260	270	280	290	300	-	-	-	-	-	-	-	-	-	-	-	-	-	-	-	-	-	-
105	250	260	270	280	290	300	-	-	-	-	-	-	-	-	-	-	-	-	-	-	-	-	-	-	-
110	260	270	280	290	300	-	-	-	-	-	-	-	-	-	-	-	-	-	-	-	-	-	-	-	-
115	270	280	290	300	-	-	-	-	-	-	-	-	-	-	-	-	-	-	-	-	-	-	-	-	-
120	280	290	300	-	-	-	-	-	-	-	-	-	-	-	-	-	-	-	-	-	-	-	-	-	-
125	290	300	-	-	-	-	-	-	-	-	-	-	-	-	-	-	-	-	-	-	-	-	-	-	-
130	300	-	-	-	-	-	-	-	-	-	-	-	-	-	-	-	-	-	-	-	-	-	-	-	-

25 mm CLIMAVER® Panel Development in one piece, in 2 pieces increase 3 cm, in 3 pieces increase 6 cm and 4 pieces increase 9 cm.

N.B.: These are interior measurements (a x b). Developing the folds and overlap adds 20 cm to the development of the 4 sides of the duct.

Straight section in two pieces («L + L» or «U + Cover») CLIMAVER® 25 mm

A/B	50	55	60	65	70	75	80	85	90	95	100	105	110	115	120	130	135	140	145	150	155	160	165	170	175	180	185	190	195	200	
10	142	152	162	172	182	192	202	212	222	232	242	252	262	272	282	292	302	312	322	332	342	352	362	372	382	392	402	412	422	432	432
15	152	162	172	182	192	202	212	222	232	242	252	262	272	282	292	302	312	322	332	342	352	362	372	382	392	402	412	422	432	442	442
20	162	172	182	192	202	212	222	232	242	252	262	272	282	292	302	312	322	332	342	352	362	372	382	392	402	412	422	432	442	452	452
25	172	182	192	202	212	222	232	242	252	262	272	282	292	302	312	322	332	342	352	362	372	382	392	402	412	422	432	442	452	462	462
30	182	192	202	212	222	232	242	252	262	272	282	292	302	312	322	332	342	352	362	372	382	392	402	412	422	432	442	452	462	472	472
35	192	202	212	222	232	242	252	262	272	282	292	302	312	322	332	342	352	362	372	382	392	402	412	422	432	442	452	462	472	482	482
40	202	212	222	232	242	252	262	272	282	292	302	312	322	332	342	352	362	372	382	392	402	412	422	432	442	452	462	472	482	492	492
45	212	222	232	242	252	262	272	282	292	302	312	322	332	342	352	362	372	382	392	402	412	422	432	442	452	462	472	482	492	502	502
50	222	232	242	252	262	272	282	292	302	312	322	332	342	352	362	372	382	392	402	412	422	432	442	452	462	472	482	492	502	512	512
55	232	242	252	262	272	282	292	302	312	322	332	342	352	362	372	382	392	402	412	422	432	442	452	462	472	482	492	502	512	522	522
60	242	252	262	272	282	292	302	312	322	332	342	352	362	372	382	392	402	412	422	432	442	452	462	472	482	492	502	512	522	532	532
65	252	262	272	282	292	302	312	322	332	342	352	362	372	382	392	402	412	422	432	442	452	462	472	482	492	502	512	522	532	542	542
70	262	272	282	292	302	312	322	332	342	352	362	372	382	392	402	412	422	432	442	452	462	472	482	492	502	512	522	532	542	552	552
75	272	282	292	302	312	322	332	342	352	362	372	382	392	402	412	422	432	442	452	462	472	482	492	502	512	522	532	542	552	562	562
80	282	292	302	312	322	332	342	352	362	372	382	392	402	412	422	432	442	452	462	472	482	492	502	512	522	532	542	552	562	572	572
85	292	302	312	322	332	342	352	362	372	382	392	402	412	422	432	442	452	462	472	482	492	502	512	522	532	542	552	562	572	582	582
90	302	312	322	332	342	352	362	372	382	392	402	412	422	432	442	452	462	472	482	492	502	512	522	532	542	552	562	572	582	592	592
95	312	322	332	342	352	362	372	382	392	402	412	422	432	442	452	462	472	482	492	502	512	522	532	542	552	562	572	582	592	-	-
100	322	332	342	352	362	372	382	392	402	412	422	432	442	452	462	472	482	492	502	512	522	532	542	552	562	572	582	592	-	-	-
105	332	342	352	362	372	382	392	402	412	422	432	442	452	462	472	482	492	502	512	522	532	542	552	562	572	582	592	-	-	-	-
110	342	352	362	372	382	392	402	412	422	432	442	452	462	472	482	492	502	512	522	532	542	552	562	572	582	592	-	-	-	-	-
115	352	362	372	382	392	402	412	422	432	442	452	462	472	482	492	502	512	522	532	542	552	562	572	582	592	-	-	-	-	-	-
120	362	372	382	392	402	412	422	432	442	452	462	472	482	492	502	512	522	532	542	552	562	572	582	592	-	-	-	-	-	-	-
125	372	382	392	402	412	422	432	442	452	462	472	482	492	502	512	522	532	542	552	562	572	582	592	-	-	-	-	-	-	-	-
130	382	392	402	412	422	432	442	452	462	472	482	492	502	512	522	532	542	552	562	572	582	592	-	-	-	-	-	-	-	-	-
135	392	402	412	422	432	442	452	462	472	482	492	502	512	522	532	542	552	562	572	582	592	-	-	-	-	-	-	-	-	-	-
140	402	412	422	432	442	452	462	472	482	492	502	512	522	532	542	552	562	572	582	592	-	-	-	-	-	-	-	-	-	-	-
145	412	422	432	442	452	462	472	482	492	502	512	522	532	542	552	562	572	582	592	-	-	-	-	-	-	-	-	-	-	-	-
150	422	432	442	452	462	472	482	492	502	512	522	532	542	552	562	572	582	592	-	-	-	-	-	-	-	-	-	-	-	-	-

 1 Panel.

 2 Panels.

N.B.: These are interior measurements (a x b).

Development of 25 mm
CLIMAVER® Panel in two
pieces (L + L or U + Cover)

CLIMAVER®

technical data sheets



Access technical data

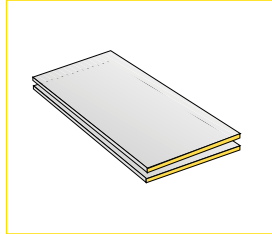

»» CLIMAVER® PLUS R

High-density Glass Wool Panel 25 mm thick, coated on both sides with aluminium complexes, and with the male edge flanged by the inner facing.

Access technical data

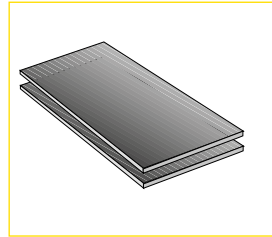

»» CLIMAVER® NETO

High-density Glass Wool Panel 25 mm thick, covered on the outside with an aluminium complex and on the inside with a net fabric (acoustic glass fabric with high mechanical resistance).

Access technical data

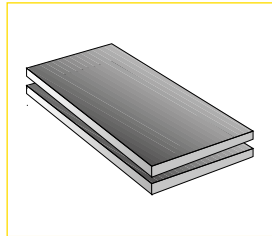

»» CLIMAVER® APTA

High-density Glass Wool Panel 40 mm thick, covered on the outside with reinforced aluminium and on the inside with a black fabric with high mechanical resistance (net fabric).

Access technical data

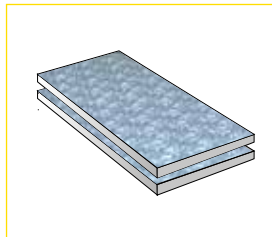

»» CLIMAVER® STAR

High-density Glass Wool Panel 40 mm thick, covered on the outside with a complex designed for the elements and on the inside with a black fabric with high mechanical resistance (net fabric).

Access technical data

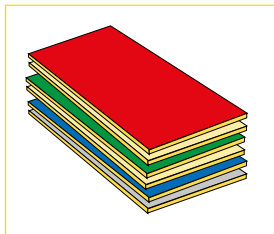

»» CLIMAVER® A2 DECO

High-density Glass Wool Panel 25 mm thick, covered on the outside with a coloured complex and on the inside with net fabric.

Access technical data

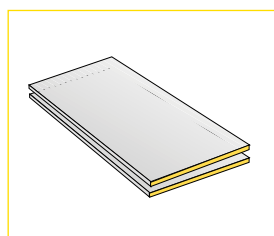

»» CLIMAVER® A2 PLUS

High-density Glass Wool Panel 25 mm thick, covered on both sides with reinforced aluminium and with the male edge flanged by the inner facing

Access technical data

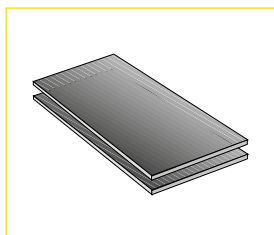

»» CLIMAVER® A2 NETO

High-density Glass Wool Panel 25 mm thick, covered on the outside with reinforced aluminium and on the inside with net fabric.

Access technical data

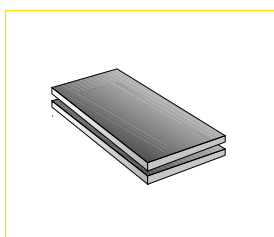

»» CLIMAVER® A2 APTA

High-density Glass Wool Panel 40 mm thick, covered on the outside with reinforced aluminium and on the inside with a black fabric with high mechanical resistance (net fabric).

Access technical data

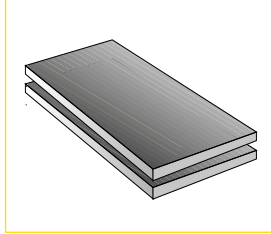

»» CLIMAVER® A1 APTA

High-density Glass Wool Panel 40 mm thick, with excellent reaction to fire A1, covered on the outside with reinforced aluminium and on the inside with a black fabric with high mechanical resistance (net fabric).

Access technical data



»» CLIMAVER® ACCESSORIES

CLIMAVER® Tapes and **Glue** for forming and sealing **CLIMAVER®** ducts to create air conditioning and ventilation installations inside buildings with **CLIMAVER®** self supporting mineral wool panels.

Access technical data



»» CLIMAVER® STAR ACCESSORIES

CLIMAVER® STAR Tape and **Glue** for forming and sealing **CLIMAVER® STAR** ducts to create air conditioning and ventilation installations outside buildings with **CLIMAVER® STAR** self-supporting mineral wool panels.

Access technical data

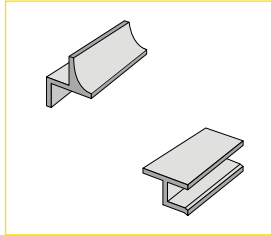

»» CLIMAVER® METAL ACCESSORIES

PERFIVER H and **PERFIVER L** aluminium profiles for making inspection panels and connecting the **CLIMAVER®** duct network to different elements of an air conditioning and ventilation installation.

To learn more about **CLIMAVER®**,
see our other documentation:

FAQ



Brochure



Quick Guide



ABOUT US

Discover the Saint-Gobain Group,
and read more about
Saint-Gobain Technical Insulation,
the world-leading supplier
of sustainable insulation solutions.



MAKING THE WORLD A BETTER HOME

Saint-Gobain designs, manufactures and distributes solutions for the construction, mobility, healthcare and other industrial application markets. Developed through a continuous innovation process, they provide wellbeing, performance and safety while addressing the challenges of sustainable construction, resource efficiency and the fight against climate change.

This strategy of responsible growth is guided by the Saint-Gobain purpose, "MAKING THE WORLD A BETTER HOME", which responds to the shared ambition of the women and men in the Group to act every day to make the world a more beautiful and sustainable place to live in.



SAINT-GOBAIN





Saint-Gobain ISOVER

Tour Saint-Gobain
12 place de l'Iris

92096 La Défense cedex - France

www.isover-technical-insulation.com

The information given in this brochure is based on our current knowledge and experience. If any information is incorrect this is not deliberate or grossly negligent. This document is not continually updated and we cannot be held responsible for any unintentional errors. For the most up-to-date information, please visit our website: www.isover-technical-insulation.com